



ZINC19 2U C236

User Guide, Rev. 1.0

Doc. ID: 1061-4051

This page has been intentionally left blank

 ZINC19 2U C236 – USER GUIDE

Disclaimer

Kontron would like to point out that the information contained in this user guide may be subject to alteration, particularly as a result of the constant upgrading of Kontron products. This document does not entail any guarantee on the part of Kontron with respect to technical processes described in the user guide or any product characteristics set out in the user guide. Kontron assumes no responsibility or liability for the use of the described product(s), conveys no license or title under any patent, copyright or mask work rights to these products and makes no representations or warranties that these products are free from patent, copyright or mask work right infringement unless otherwise specified. Applications that are described in this user guide are for illustration purposes only. Kontron makes no representation or warranty that such application will be suitable for the specified use without further testing or modification. Kontron expressly informs the user that this user guide only contains a general description of processes and instructions which may not be applicable in every individual case. In cases of doubt, please contact Kontron.

This user guide is protected by copyright. All rights are reserved by Kontron. No part of this document may be reproduced, transmitted, transcribed, stored in a retrieval system, or translated into any language or computer language, in any form or by any means (electronic, mechanical, photocopying, recording, or otherwise), without the express written permission of Kontron. Kontron points out that the information contained in this user guide is constantly being updated in line with the technical alterations and improvements made by Kontron to the products and thus this user guide only reflects the technical status of the products by Kontron at the time of publishing.

Brand and product names are trademarks or registered trademarks of their respective owners.

©2017 by Kontron AG

Kontron AG

Lise-Meitner-Str. 3-5
86156 Augsburg
Germany
www.kontron.com

High Risk Applications Hazard Notice

THIS DEVICE AND ASSOCIATED SOFTWARE ARE NOT DESIGNED, MANUFACTURED OR INTENDED FOR USE OR RESALE FOR THE OPERATION OF NUCLEAR FACILITIES, THE NAVIGATION, CONTROL OR COMMUNICATION SYSTEMS FOR AIRCRAFT OR OTHER TRANSPORTATION, AIR TRAFFIC CONTROL, LIFE SUPPORT OR LIFE SUSTAINING APPLICATIONS, WEAPONS SYSTEMS, OR ANY OTHER APPLICATION IN A HAZARDOUS ENVIRONMENT, OR REQUIRING FAIL-SAFE PERFORMANCE, OR IN WHICH THE FAILURE OF PRODUCTS COULD LEAD DIRECTLY TO DEATH, PERSONAL INJURY, OR SEVERE PHYSICAL OR ENVIRONMENTAL DAMAGE (COLLECTIVELY, "HIGH RISK APPLICATIONS").

You understand and agree that your use of Kontron devices as a component in High Risk Applications is entirely at your risk. To minimize the risks associated with your products and applications, you should provide adequate design and operating safeguards. You are solely responsible for compliance with all legal, regulatory, safety, and security related requirements concerning your products. You are responsible to ensure that your systems (and any Kontron hardware or software components incorporated in your systems) meet all applicable requirements. Unless otherwise stated in the product documentation, the Kontron device is not provided with error-tolerance capabilities and cannot therefore be deemed as being engineered, manufactured or setup to be compliant for implementation or for resale as device in High Risk Applications. All application and safety related information in this document (including application descriptions, suggested safety measures, suggested Kontron products, and other materials) is provided for reference only

Revision History

Revision	Brief Description of Changes	Date of Issue
1.0	Initial Version	2017-Apr-19

Terms and Conditions

Kontron warrants products in accordance with defined regional warranty periods. For more information about warranty compliance and conformity, and the warranty period in your region, visit <http://www.kontron.com/terms-and-conditions>.

Kontron sells products worldwide and declares regional General Terms & Conditions of Sale, and Purchase Order Terms & Conditions. Visit <http://www.kontron.com/terms-and-conditions>.

For contact information, refer to the corporate offices contact information on the last page of this user guide or visit our website [CONTACT US](#).

Customer Support

Find Kontron contacts by visiting: <http://www.kontron.com/support>.

Customer Service

As a trusted technology innovator and global solutions provider, Kontron extends its embedded market strengths into a services portfolio allowing companies to break the barriers of traditional product lifecycles. Proven product expertise coupled with collaborative and highly-experienced support enables Kontron to provide exceptional peace of mind to build and maintain successful products.

For more details on Kontron's service offerings such as: enhanced repair services, extended warranty, Kontron training academy, and more visit <http://www.kontron.com/support-and-services/services>.

Customer Comments

If you have any difficulties using this user guide, discover an error, or just want to provide some feedback, contact [Kontron support](#). Detail any errors you find. We will correct the errors or problems as soon as possible and post the revised user guide on our website.

Symbols

The following symbols may be used in this manual

DANGER

DANGER indicates a hazardous situation which, if not avoided, will result in death or serious injury.

WARNING

WARNING indicates a hazardous situation which, if not avoided, could result in death or serious injury.

CAUTION

CAUTION indicates a hazardous situation which, if not avoided, may result in minor or moderate injury.

NOTICE

NOTICE indicates a property damage message.



Electric Shock!

This symbol and title warn of hazards due to electrical shocks (> 60 V) when touching products or parts of them. Failure to observe the precautions indicated and/or prescribed by the law may endanger your life/health and/or result in damage to your material.

Please refer also to the "High-Voltage Safety Instructions" portion below in this section.



ESD Sensitive Device!

This symbol and title inform that the electronic boards and their components are sensitive to static electricity. Care must therefore be taken during all handling operations and inspections of this product in order to ensure product integrity at all times.



HOT Surface!

Do NOT touch! Allow to cool before servicing.



This symbol indicates general information about the product and the user manual.

This symbol also indicates detail information about the specific product configuration.



This symbol precedes helpful hints and tips for daily use.

For Your Safety

Your new Kontron product was developed and tested carefully to provide all features necessary to ensure its compliance with electrical safety requirements. It was also designed for a long fault-free life. However, the life expectancy of your product can be drastically reduced by improper treatment during unpacking and installation. Therefore, in the interest of your own safety and of the correct operation of your new Kontron product, you are requested to conform with the following guidelines.

High Voltage Safety Instructions

As a precaution and in case of danger, the power connector must be easily accessible. The power connector is the product's main disconnect device.

CAUTION

Warning

All operations on this product must be carried out by sufficiently skilled personnel only.

CAUTION



Electric Shock!

Before installing a non-hot-swappable Kontron product into a system always ensure that your mains power is switched off. This also applies to the installation of piggybacks. Serious electrical shock hazards can exist during all installation, repair, and maintenance operations on this product. Therefore, always unplug the power cable and any other cables which provide external voltages before performing any work on this product.

Earth ground connection to vehicle's chassis or a central grounding point shall remain connected. The earth ground cable shall be the last cable to be disconnected or the first cable to be connected when performing installation or removal procedures on this product.

Special Handling and Unpacking Instruction

NOTICE



ESD Sensitive Device!

Electronic boards and their components are sensitive to static electricity. Therefore, care must be taken during all handling operations and inspections of this product, in order to ensure product integrity at all times.

Do not handle this product out of its protective enclosure while it is not used for operational purposes unless it is otherwise protected.

Whenever possible, unpack or pack this product only at EOS/ESD safe work stations. Where a safe work station is not guaranteed, it is important for the user to be electrically discharged before touching the product with his/her hands or tools. This is most easily done by touching a metal part of your system housing.

It is particularly important to observe standard anti-static precautions when changing piggybacks, ROM devices, jumper settings etc. If the product contains batteries for RTC or memory backup, ensure that the product is not placed on conductive surfaces, including anti-static plastics or sponges. They can cause short circuits and damage the batteries or conductive circuits on the product.

Lithium Battery Precautions

If your product is equipped with a lithium battery, take the following precautions when replacing the battery.

CAUTION

Danger of explosion if the battery is replaced incorrectly.

- ▶ Replace only with same or equivalent battery type recommended by the manufacturer.
- ▶ Dispose of used batteries according to the manufacturer's instructions.

General Instructions on Usage

In order to maintain Kontron's product warranty, this product must not be altered or modified in any way. Changes or modifications to the product, that are not explicitly approved by Kontron and described in this user guide or received from Kontron Support as a special handling instruction, will void your warranty.

This product should only be installed in or connected to systems that fulfill all necessary technical and specific environmental requirements. This also applies to the operational temperature range of the specific board version that must not be exceeded. If batteries are present, their temperature restrictions must be taken into account.

In performing all necessary installation and application operations, only follow the instructions supplied by the present user guide.

Keep all the original packaging material for future storage or warranty shipments. If it is necessary to store or ship the product then re-pack it in the same manner as it was delivered.

Special care is necessary when handling or unpacking the product. See Special Handling and Unpacking Instruction.

Quality and Environmental Management

Kontron aims to deliver reliable high-end products designed and built for quality, and aims to complying with environmental laws, regulations, and other environmentally oriented requirements. For more information regarding Kontron's quality and environmental responsibilities, visit <http://www.kontron.com/about-kontron/corporate-responsibility/quality-management>.

Disposal and Recycling

Kontron's products are manufactured to satisfy environmental protection requirements where possible. Many of the components used are capable of being recycled. Final disposal of this product after its service life must be accomplished in accordance with applicable country, state, or local laws or regulations.

WEEE Compliance

The Waste Electrical and Electronic Equipment (WEEE) Directive aims to:

- ▶ Reduce waste arising from electrical and electronic equipment (EEE)
- ▶ Make producers of EEE responsible for the environmental impact of their products, especially when the product become waste
- ▶ Encourage separate collection and subsequent treatment, reuse, recovery, recycling and sound environmental disposal of EEE
- ▶ Improve the environmental performance of all those involved during the lifecycle of EEE



Environmental protection is a high priority with Kontron.

Kontron follows the WEEE directive

You are encouraged to return our products for proper disposal.

Table of Contents

Symbols.....	6
For Your Safety.....	7
High Voltage Safety Instructions	7
Special Handling and Unpacking Instruction	7
Lithium Battery Precautions.....	8
General Instructions on Usage.....	8
Quality and Environmental Management.....	8
Disposal and Recycling.....	8
WEEE Compliance.....	8
Table of Contents	9
List of Tables.....	10
List of Figures	11
1/ General Safety Instructions for IT Equipment	12
1.1. Electrostatic Discharge (ESD).....	13
1.1.1. Grounding Methods	13
1.2. Instructions for the optional Lithium Battery.....	13
2/ Electromagnetic Compatibility.....	14
2.1. Electromagnetic Compatibility EU.....	14
2.2. FCC Statement (U.S.A.).....	14
3/ Scope of Delivery.....	15
3.1. Type Label and Product Identification	15
4/ Product Description.....	16
4.1. Front Side.....	18
4.1.1. Power Button.....	19
4.1.2. LED Indicators.....	20
4.1.3. Ports on the Front Side.....	20
4.1.4. Cover fastening screw on the front side.....	21
4.1.5. Filter Mat and Filter Mat Holder	21
4.1.6. Fan Slide-in Module.....	21
4.1.7. Drive Bays.....	21
4.2. Rear Side	22
4.2.1. System Configuration with Motherboard and Riser Card.....	22
4.2.2. System Configuration with Motherboard and Low-Profile Cards	23
4.2.3. Power Supply	24
4.2.4. Stud for Chassis Grounding.....	25
4.2.5. Fan Slide-In Module and Temperature Sensor.....	25
4.3. Side View	25
4.4. System Configurations with Low-Profile Cards or Riser card.....	26
4.4.1. Low-Profile / Riser Card Version and available PCIe Slots	28
5/ Installation and Removal.....	29
5.1. Attaching the Rubber Feet.....	29
5.2. Cover	30
5.3. Accessing Internal Components.....	31
5.3.1. Installing /Removing Expansion Cards	31
5.4. Installation in a 19" Industrial Cabinet.....	34
6/ Starting Up.....	35

6.1. AC Power Connection.....	35
6.2. Operating System and Hardware Components Drivers.....	36
7/ Maintenance and Prevention	37
7.1. Replacing System Fans	37
7.2. Cleaning the Filter Mat.....	39
7.3. Replacing the Lithium Battery.....	41
8/ Mounting	42
9/ Technical Data	43
9.1. Electrical Specifications.....	44
9.2. Mechanical Specifications.....	44
9.3. Environmental Specifications	44
9.4. Directives and Standards	45
10/ Standard Interfaces – Pin Assignments	46
10.1. PS/2 Mouse Connector.....	46
10.2. PS/2 Keyboard Connector	46
10.3. Serial Interface (RS232).....	46
10.4. DisplayPort.....	47
10.5. Ethernet Connector	47
10.6. USB 3.0 Port.....	47
10.7. USB 2.0 Port.....	48
10.8. DVI-D Port.....	48
Appendix A: List of Acronyms.....	49
About Kontron	50

List of Tables

Table 1: Type label and product identification.....	15
Table 2: LED indicators	20
Table 3: Drive Bays.....	21
Table 4: Available PCIe Slots.....	28
Table 5: Technical Data	43
Table 6: Mechanical specifications	44
Table 7: Environmental Specifications	44
Table 8: Directives and Standards.....	45
Table 9: PS/2 Mouse Connector	46
Table 10: PS/2 Keyboard Connector.....	46
Table 11: Serial Interface (RS232).....	46
Table 12: DisplayPort.....	47
Table 13: Ethernet Connector	47
Table 14: USB 3.0 Port	47
Table 15: USB 2.0 Port	48
Table 16: DVI-D Port.....	48
Table 17: List of Acronyms	49

List of Figures

Figure 1: Rackmount Version with closed access panel.....	16
Figure 2: Desktop Version with closed access panel	16
Figure 3: Rackmount Version with opened access panel.....	16
Figure 4: Desktop version with opened access panel.....	16
Figure 5: ZINC19 2U C236 Platform.....	17
Figure 6: Front (Rackmount Version) with closed front Access Panel.....	18
Figure 7: 19" Bracket with Fixing Screws	18
Figure 8: Front (Rackmount Version) with open Front Access Panel	19
Figure 9: Power Button on the Front.....	19
Figure 10: LED Indicators	20
Figure 11: USB Ports on the Front Side.....	20
Figure 12: Rear Side of the ZINC19 2U C236 with Riser Card	22
Figure 13: Rear side of the ZINC19 2U C236 with Low-Profile Expansion Cards	23
Figure 14: External Ports of the Motherboard.....	24
Figure 15: Detail: AC Wide Range PSU	24
Figure 16: Grounding stud marked with "Chassis Ground" symbol.....	25
Figure 17: ZINC19 2U C236 - Side View.....	25
Figure 18: ZINC19 2U C236 - Configuration with Riser Card	26
Figure 19: ZINC19 2U C236 - Configuration with Low-Profile Cards.....	27
Figure 20: Inside of the Cover with Fixing Brackets.....	30
Figure 21: Loosen the Cover fastening knurled Screw on the Front Side	31
Figure 22: Loosen the knurled Screw on the Rear Side	31
Figure 23: Pulling the Cover backwards.....	32
Figure 24: Removing the Cover	32
Figure 25: Mounting an Expansion Card to the Riser Card (not for Configurations with Low-Profile Cards).....	32
Figure 26: Detail: removing the Fan Slide-In Module	37
Figure 27: Detail: Fan compartment (without Fan Slide-In Module).....	37
Figure 28: Fan Slide-In Module without Filter Mat Holder.....	38
Figure 29: Rear View of the Fan Slide-In Module.....	38
Figure 30: Fan Slide-In Module with mounted Filter Mat Holder.....	38
Figure 31: Side View of the Fan Slide-In Module	38
Figure 32: Detail with Filter Mat Holder on the Front Side of the ZINC19 2U C236 Platform	39
Figure 33: Detail without Filter Mat Holder on the Front Side	40
Figure 34: Filter Mat Holder without Filter Mat	40
Figure 35: Filter Mat Holder with Filter Mat	40
Figure 36: Filter Mat.....	40
Figure 37: Threaded holes (M4x6) for mounting the ZINC19 2U C236 System (shown as Left Side View).....	42

1/ General Safety Instructions for IT Equipment

▲WARNING



Please read this chapter carefully and take careful note of the instructions, which have been compiled for your safety and to ensure to apply in accordance with intended regulations. If the following general safety instructions are not observed, it could lead to injuries to the operator and/or damage of the product; in cases of nonobservance of the instructions Kontron is exempt from accident liability, this also applies during the warranty period.

The product has been built and tested according to the basic safety requirements for low voltage (LVD) applications and has left the manufacturer in safety-related, flawless condition. To maintain this condition and also to ensure safe operation, the operator must not only observe the correct operating conditions for the product but also the following general safety instructions:

- ▶ The product must be used as specified in the product documentation, in which the instructions for safety for the product and for the operator are described. These contain guidelines for setting up, installation and assembly, maintenance, transport or storage.
- ▶ The on-site electrical installation must meet the requirements of the country's specific local regulations.
- ▶ If a power cable comes with the product, only this cable should be used. Do not use an extension cable to connect the product.
- ▶ To guarantee that sufficient air circulation is available to cool the product, please ensure that the ventilation openings are not covered or blocked. If an air filter is provided, this should be cleaned regularly. Do not place the system close to heat sources or damp places. Make sure the system is well ventilated.
- ▶ Only devices or parts which fulfill the requirements of SELV circuits (Safety Extra Low Voltage) as stipulated by IEC 60950-1 may be connected to the available interfaces.
- ▶ Before opening the device, make sure that the device is disconnected from the mains.
- ▶ Switching off the device by its power button does not disconnect it from the mains. Complete disconnection is only possible if the power cable is removed from the wall plug or from the device. Ensure that there is free and easy access to enable disconnection.
- ▶ The device may only be opened for the insertion or removal of add-on cards (depending on the configuration of the system). This may only be carried out by qualified operators.
- ▶ If extensions are being carried out, the following must be observed:
 - ▶ All effective legal regulations and all technical data are adhered to.
 - ▶ The power consumption of any add-on card does not exceed the specified limitations.
 - ▶ The current consumption of the system does not exceed the value stated on the product label.
- ▶ Only original accessories that have been approved by Kontron can be used.
- ▶ Please note: safe operation is no longer possible when any of the following applies:
 - ▶ The device has visible damages.
 - ▶ The device is no longer functioning.

In this case the device must be switched off and it must be ensured that the device can no longer be operated.

1.1. Electrostatic Discharge (ESD)



A sudden discharge of electrostatic electricity can destroy static-sensitive devices or micro-circuitry.

Therefore proper packaging and grounding techniques are necessary precautions to prevent damage. Always take the following precautions:

1. Transport boards in ESD-safe containers such as boxes or bags.
2. Keep electrostatic sensitive parts in their containers until they arrive at the ESD-safe workplace.
3. Always be properly grounded when touching a sensitive board, component, or assembly.
4. Store electrostatic-sensitive boards in protective packaging or on antistatic mats.

1.1.1. Grounding Methods

By adhering to the guidelines below, electrostatic damage to the device can be avoided:

1. Cover workstations with approved antistatic material. Always wear a wrist strap connected to workplace. Always use properly grounded tools and equipment.
2. Use antistatic mats, heel straps, or air ionizers for more protection.
3. Always handle electrostatically sensitive components by their edge or by their casing.
4. Avoid contact with pins, leads, or circuitry.
5. Turn off power and input signals before inserting and removing connectors or connecting test equipment.
6. Keep work area free of non-conductive materials such as ordinary plastic assembly aids and Styrofoam.
7. Use only field service tools which are conductive, such as cutters, screwdrivers, and vacuum cleaners.
8. Always place drives and boards PCB-assembly-side down on the foam.

1.2. Instructions for the optional Lithium Battery

If ordered, your ZINC19 2U C236 is equipped with an optional lithium battery. For the replacement of this battery please observe the instructions described in section 7.3 "Replacing the Lithium Battery".

▲WARNING

Danger of explosion when replacing with wrong type of battery. Replace only with the same or equivalent type recommended by the manufacturer. The lithium battery type must be UL recognized.



Do not dispose of lithium batteries in general trash collection. Dispose of the battery according to the local regulations dealing with the disposal of these special materials, (e.g. to the collecting points for dispose of batteries).

2/ Electromagnetic Compatibility

For detailed information refer to section 9.4 "Directives and Standards".

2.1. Electromagnetic Compatibility EU

This product has been designed for low level of radiated emission for residential, commercial and light-industrial environments and high immunity level for industrial environmental. This product complies with the European Council Directive on the approximation of the laws of the member states relating to electromagnetic compatibility (EMC Directive 2014/30/EU).

This product is intended for use in industrial areas. The most recent version of the EMC guidelines (EMC Directive 2014/30/EU) and/or the German EMC laws apply. If the user modifies and/or adds to the equipment (e.g. installation of add-on cards) the prerequisites for the CE conformity declaration (safety requirements) may no longer apply.

2.2. FCC Statement (U.S.A.)

Kontron Europe GmbH is not responsible for any radio television interference caused by unauthorized modifications of this equipment or the substitution or attachment of connecting cables and equipment other than those specified by Kontron Europe GmbH. The correction of interference caused by such unauthorized modification, substitution or attachment will be the responsibility of the user.

The use of shielded I/O cables is required when connecting this equipment to any and all optional peripheral or host devices. Failure to do so may violate FCC and ICES rules

3/ Scope of Delivery

Please check that your package is complete, and contains the items below (according to the ordered unit configuration). If you discover damaged or missing items, please contact your dealer.

- ▶ ZINC19 2U C236 platform (system configuration ordered)
- ▶ 2x key for the front access panel lock
- ▶ 1x AC power cable (for AC system configuration)
- ▶ Rubber feet (self-adhesive)
- ▶ General Safety Instruction for IT Equipment

3.1. Type Label and Product Identification

The type label (product designation, serial number) and the inspection status label of your ZINC19 2U C236 platform are located on the right side of the device.

Table 1: Type label and product identification

Type	Model (Product Identification)
ZINC19 2U C236	YYYYY-YY-YYYY-Y-Y

4/ Product Description

The ZINC19 2U C236 is a scalable 2U (19") platform, equipped with a motherboard board, supporting various system configurations. The flexible customer-specific hardware system configuration and the robust construction with excellent mechanical stability of the ZINC19 2U C236 platform offer the superior qualities of a computer designed for operation in harsh industrial environment.

The ZINC19 2U C236 platform is designed to be installed in 19" racks. It may be also installed as a desktop unit.

Versions of the ZINC19 2U C236 platform:

Figure 1: Rackmount Version with closed access panel



Figure 2: Desktop Version with closed access panel



Figure 3: Rackmount Version with opened access panel

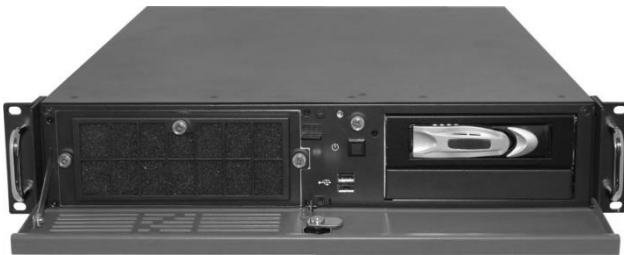
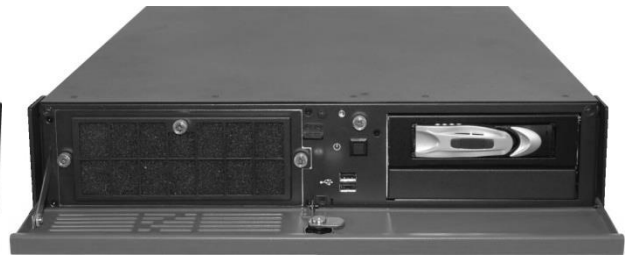

Figure 4: Desktop version with opened access panel



The system can be equipped with up to two drive bays (depending on the system configuration):

- ▶ **Bay1:** one 5.25" front accessible drive bay
- ▶ **Bay2:** one 3.5" internal drive bay or an front accessible slim drive

The device is equipped with an AC wide range power supply.

The controls of the ZINC19 2U C236 platform are located behind the front access panel and consist, as standard, of a power button, a power and a HDD LED.

Two system fans are installed at the front side of the unit. These are attached to the system by a fan slide-in module (hot-swap). The fan slide-in module simplifies the installation and removal of these components.

The washable filter mat, which protects your system against dust and dirt, is located on the front side of the system. This filter mat can be replaced during operation.

Your system can be expanded with different expansion cards.

The type label is located on the right hand side of the device.

Figure 5: ZINC19 2U C236 Platform



The ZINC19 2U C236 platform is designed to be operated in horizontal position only.
When powering on the ZINC19 2U C236 platform, make sure that the air intake and exhaust openings are not obstructed by objects.

4.1. Front Side

The ZINC19 2U C236 platform is available as a rackmount version.

Figure 6: Front (Rackmount Version) with closed front Access Panel

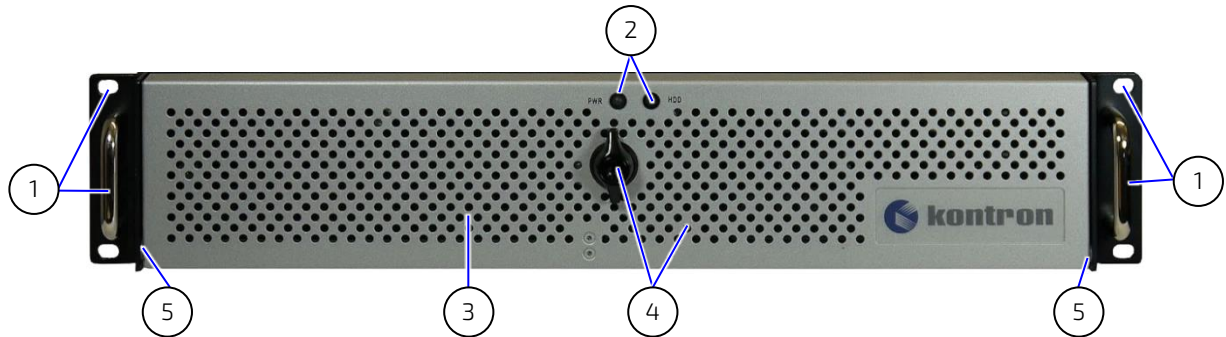

- | | |
|--|--|
| 1 19" bracket with handle | 3 Ventilation grille on the front access panel |
| 2 Light diffusers for HDD and power LEDs | 4 Front access panel with a locking mechanism |
| | 5 Plastic washer |

You can easily convert your system to a desktop version. Unscrew the left and right hand 19" brackets from the device. To attach the rubber feet (included), please follow the instructions in the section 5.1 "Attaching the Rubber Feet".

Figure 7: 19" Bracket with Fixing Screws

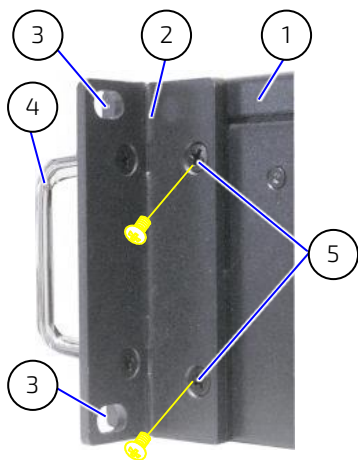

- | |
|--|
| 1 ZINC19 2U C236 platform chassis |
| 2 19" bracket with handle |
| 3 Holes for rack mounting |
| 4 Handle |
| 5 Screws for attaching the 19" bracket |

The Power button, the USB ports and the integrated 5.25" drive bay are located on the front side (Figure 8, pos. 7, 8, 10) of the ZINC19 2U C236 platform, behind the front access panel.

Figure 8: Front (Rackmount Version) with open Front Access Panel

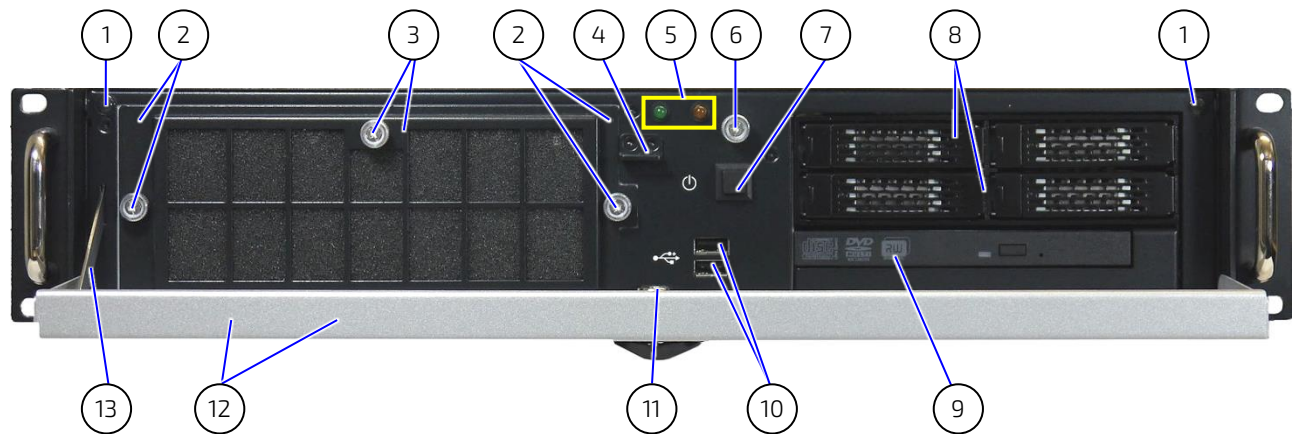

- | | |
|--|--|
| 1 Bump stop for the front access panel | 8 Bay1: 1x 5.25" front-accessible drive bay (shown with 4x 2.5" removable HDD) |
| 2 Fan slide-in module with knurled screws | 9 Bay2: 1x internal 3.5" drive bay or 1x front-accessible slim drive (shown with DVD drive) |
| 3 Filter mat holder with fixing screw | 10 2x USB (2.0) ports |
| 4 Slot for the locking mechanism | 11 Securing lock mechanism (two keys are provided) |
| 5 Indicators (power LED, HDD activity LED) | 12 Front access panel with ventilation grille |
| 6 Cover fastening screw on the front side | 13 Holder for the front access panel |
| 7 Power button | |

4.1.1. Power Button

Figure 9: Power Button on the Front



The power button (refer to Figure 9 , and Figure 8, pos. 7) is located at the front side of the platform, behind the front access panel and allows to power ON/OFF the system.

⚠ WARNING

Please observe that turning the power off using the power button (refer to Figure 8, pos. 7) does not disconnect the ZINC19 2U C236 platform from the AC/DC power source.

There is still a standby-voltage of 5 V_{sb} on the motherboard (refer also to the hint in the subsection 4.2.3).

The unit is completely disconnected from the mains, only when the power cord is disconnected either from the mains or the unit. Therefore, the power cord and its connectors must always remain easily accessible.

⚠ CAUTION

Performing a forced shut down can lead to loss of data or other undesirable effects!

4.1.2. LED Indicators

The LED indicators (refer to Figure 8, pos. 5 and Figure 10) of the ZINC19 2U C236 are located at the front of the device, behind the front access panel.

Figure 10: LED Indicators

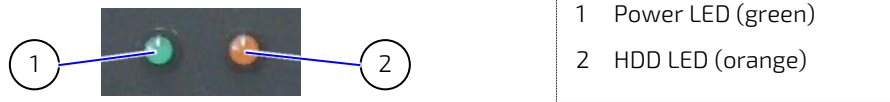

Table 2: LED indicators

Power LED (green)	This LED (Figure 10, pos. 1) is green when the system is switched on using the Power On/Off button. Requirement: The system must be connected to the power source (AC), using the corresponding power cable.
HDD LED (orange)	This LED (Figure 10, pos. 2) is orange when the hard disk is accessed.

4.1.3. Ports on the Front Side

4.1.3.1. USB Ports

ZINC19 2U C236 is equipped with two USB (2.0) ports on the front (Figure 8, pos. 10 and Figure 11). You can connect various USB devices to these two USB 2.0 interface connectors.

Figure 11: USB Ports on the Front Side

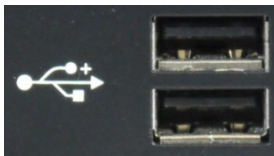

4.1.3.2. Front Access Panel

The securing lock mechanism (Figure 8, pos. 11) located at the access panel allows you, if required, to protect your system from unauthorized use. When the access panel is locked, the cover of the ZINC19 2U C236 system cannot be removed, and the drives, filter mat holder and power button are not accessible.



If USB devices are connected to the USB ports on the front of the device, the front access panel cannot be closed and locked.

The key should be stored somewhere where it is not accessible to unauthorized persons.

4.1.4. Cover fastening screw on the front side

The cover fastening screw (Figure 8, pos. 6) secures the cover to the chassis on the front side.



To remove the cover of the ZINC19 2U C236 platform, the following knurled screws have to be loosened:

- ▶ The cover fastening screw (Figure 8, pos. 6) on the front side
- ▶ The knurled screws (Figure 12 pos. 5, Figure 13, pos. 5) on the rear side

The chassis of the ZINC19 2U C236 platform is properly closed only if the cover is attached and the abovementioned screws are fastened.

4.1.5. Filter Mat and Filter Mat Holder

The filter mat and the filter mat holder (Figure 8, pos. 3) are located behind the air grilles of the front access door (Figure 6, pos. 3). The filter mat holder is fastened to the fan slide-in module (Figure 34, pos. 4) by a knurled screw (Figure 34, pos. 5). The filter mat is inserted in the filter mat holder (Figure 35). This filter mat protects your system against dust and dirt (see section 7.2 "Cleaning the Filter Mat").

4.1.6. Fan Slide-in Module

The two system fans are integrated in a user-friendly, replaceable fan slide-in module (hot-swap) (see subsection 4.2.5 "Fan Slide-In Module and Temperature Sensor"). The fan slide-in module (Figure 8, pos. 2) can be replaced as described in the section 7.1 "Replacing System Fans".

4.1.7. Drive Bays

Depending on the ordered system configuration, your ZINC19 2U C236 can be equipped with up to two drive bays (see Figure 8, pos. 8 and 9).

Table 3: Drive Bays

Drive Bay	Description (refer to Figure 8)
Bay1	▶ one externally accessible 5.25" drive bay (shown with 4x 2.5" removable HDD installed)
Bay2	▶ one internal 3.5" drive bay for a SATA HDD (shown with an internal, not externally accessible HDD installed) or ▶ a front accessible 5.25" slim-line drive bay (shown)



The Hot Swap disk subsystems allows replacing of the SATA HDDs/SSDs during operation.

4.2. Rear Side

On the rear side, depending on the ordered ZINC19 2U C236 platform configuration, are available the external interfaces of the integrated motherboard, the additional interfaces, the power supply unit and the air exhaust openings.

4.2.1. System Configuration with Motherboard and Riser Card

Figure 12: Rear Side of the ZINC19 2U C236 with Riser Card

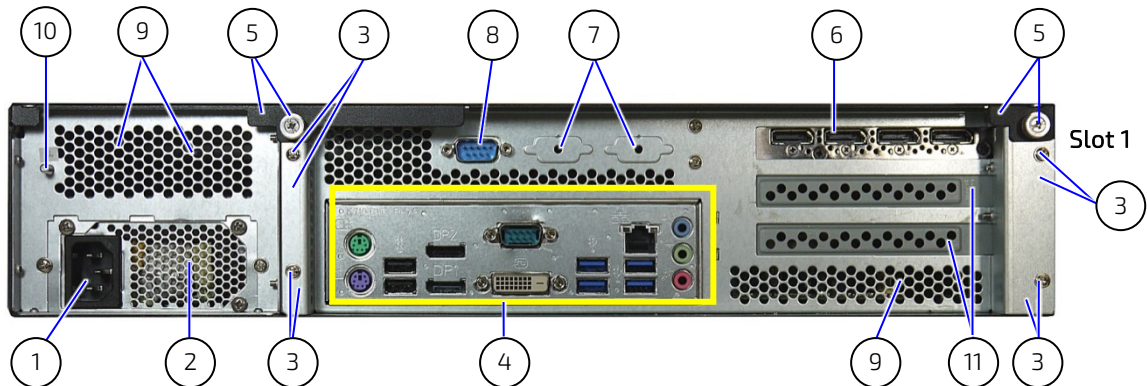

- | | |
|--|---|
| 1 AC inlet connector | 6 Graphics adapter (Slot 1; see also section 4.4.1 "Low-Profile / Riser Card Version and available PCIe Slots") |
| 2 Ventilation holes of the Power Supply Unit (PSU) | 7 Cut-outs for optional (customer-specific) interfaces routed to the rear (9-pin D-SUB type) |
| 3 Card cage (for motherboard and expansion cards) with fixing screws | 8 Additional serial port (RS232) |
| 4 External interfaces of the motherboard | 9 Air exhaust openings |
| 5 Rear side of the cover with captive knurled screws | 10 Chassis grounding stud |
| | 11 Mechanical slot (not used) |

4.2.2. System Configuration with Motherboard and Low-Profile Cards

Figure 13: Rear side of the ZINC19 2U C236 with Low-Profile Expansion Cards

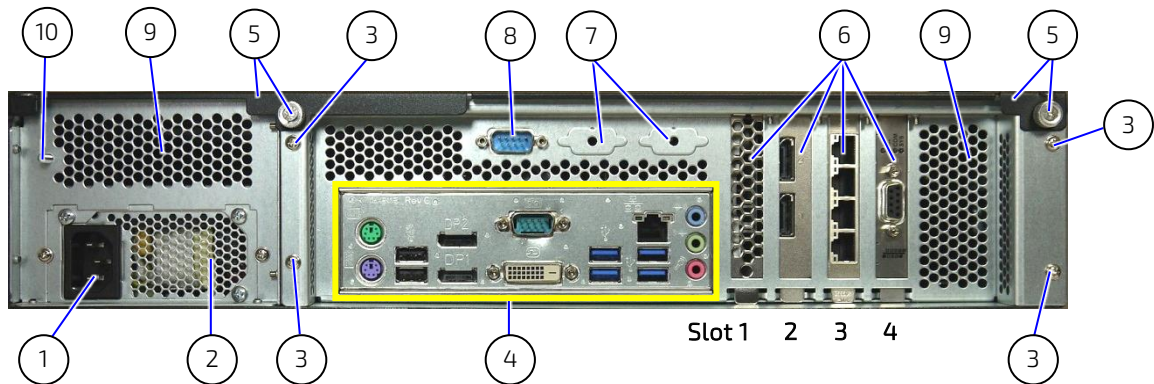

- | | |
|--|--|
| <ul style="list-style-type: none"> 1 AC inlet connector 2 Ventilation holes of the Power Supply Unit (PSU) 3 Card cage (for motherboard and expansion cards) with fixing screws 4 External interfaces of the motherboard | <ul style="list-style-type: none"> 5 Rear side of the cover with captive knurled screws 6 Slot brackets (1 to 4) for expansion cards (see also section 4.4.1 "Low-Profile / Riser Card Version and available PCIe Slots") 7 Cut-outs for optional (customer-specific) interfaces routed to the rear (9-pin D-SUB type) 8 Additional serial port (RS232) 9 Air exhaust openings 10 Chassis grounding stud |
|--|--|

4.2.2.1. External Interfaces of the Motherboard

Figure 14: External Ports of the Motherboard

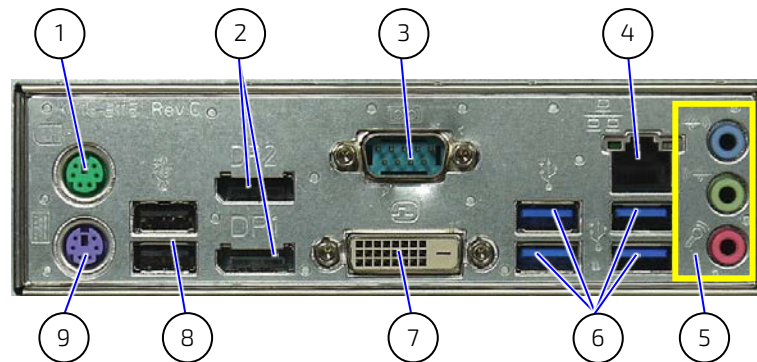

- | | |
|---|--------------------|
| 1 PS/2 mouse port (green) | 5 Audio connectors |
| 2 2x DisplayPort | 6 4x USB 3.0 ports |
| 3 Serial port (RS232) | 7 DVI-D port |
| 4 Ethernet port (RJ45),
(10/100/1000 Mbps) | 8 2x USB 2.0 ports |
| 9 PS/2 keyboard port (purple) | |

4.2.2.2. Additional Ports

Your system is equipped with on-board interfaces (e.g. serial interface) routed to the rear panel (refer to Figure 12, pos. 8 and Figure 13, pos. 8). These ports allow you to connect different peripherals.



More information can be found on our web site at www.kontron.com by selecting the product

4.2.3. Power Supply

The power supply is located on the rear side of the ZINC19 2U C236 platform. The corresponding nominal voltage range can be found on the type label on the right side of the system.

Figure 15: Detail: AC Wide Range PSU

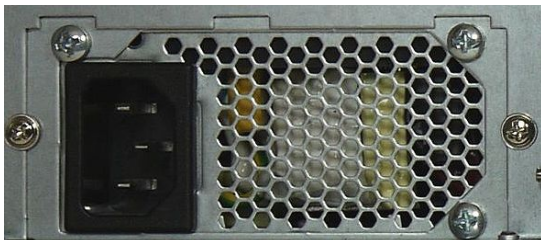

CAUTION

Even if you turn off the system using the power button (Figure 8, pos. 7), there is still a standby-voltage of 5 V_{sb} on the motherboard.

4.2.4. Stud for Chassis Grounding

The grounding stud is located on the rear side of the ZINC19 2U C236 platform (see Figure 12, pos. 10 and Figure 13, pos. 10).

⚠ CAUTION

The ZINC19 2U C236 systems with grounding studs marked with a "Chassis Ground" symbol (Figure 16) have to be grounded appropriately.

Figure 16: Grounding stud marked with "Chassis Ground" symbol

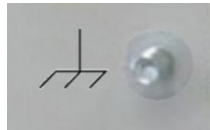

4.2.5. Fan Slide-In Module and Temperature Sensor

The two system fans are securely installed in a user-friendly, interchangeable fan-slide-in module (Hot-Swap). The fan slide-in module is mounted in the fan compartment on the front of the device.

The systems fans are temperature-controlled via the temperature sensors that are built in the system. Thus, sufficient airflow is ensured for an optimal, active cooling of the system.

⚠ CAUTION

The operation of the ZINC19 2U C236 platform is permitted only with a functional fan slide-in module (refer to the "Replacing System Fans" section).

Defective components may be replaced only by Kontron original spare parts.

▶ Part number of the fan slide-in module: 1050-8442.

4.3. Side View

On the left and right sides of the device, there are six M4 threaded screw holes, for installing the ZINC19 2U C236 platform in a 19" industrial cabinet using slide rails (refer also to chapter 8/ "Mounting").

Figure 17: ZINC19 2U C236 - Side View

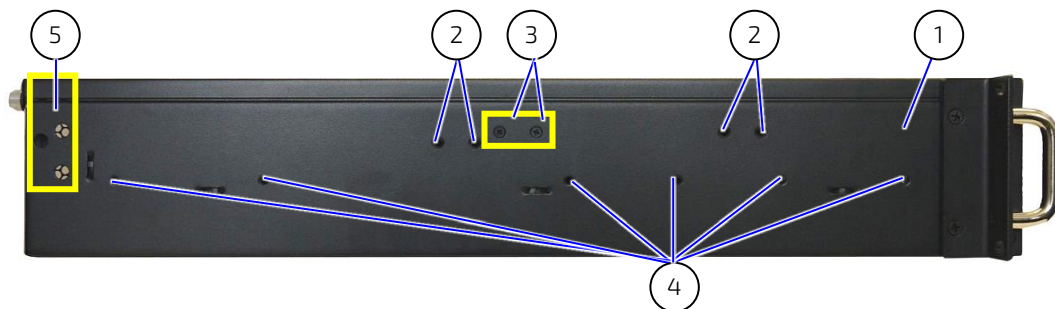

- | | | | |
|---|---|---|--|
| 1 | Side view of the ZINC19 2U C236 platform | 4 | 6x M4 threaded screw holes (on both sides) |
| 2 | 3x two M3 threaded screw holes used for mounting of card holder | 5 | Holes for installing/removing add-on cards to the riser card |
| 3 | Fastening screws for the card holder (the position can be different ; see pos. 2) | | |

4.4. System Configurations with Low-Profile Cards or Riser card

Please observe that the ZINC19 2U C236 platform is designed to be operated in horizontal position only.

Figure 18: ZINC19 2U C236 - Configuration with Riser Card

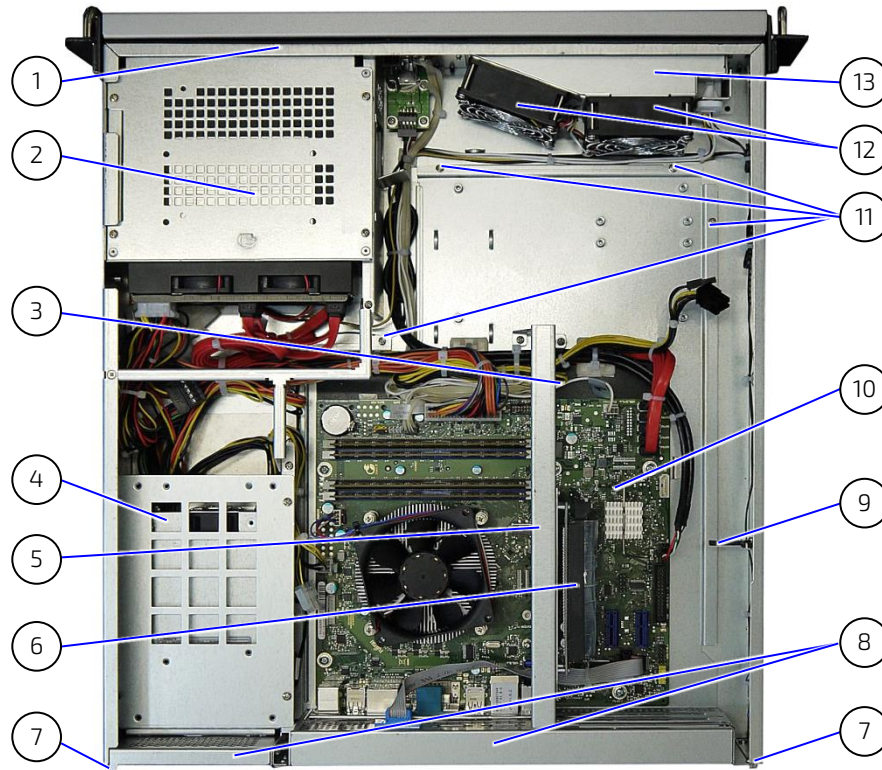

- | | | | |
|---|--|----|--|
| 1 | Cover retaining plate on the front side | 7 | Centering latches for the cover at the rear side |
| 2 | Bay1 and Bay2 : Drives (stacked one above the other into a drive cage) | 8 | Cover retaining plate on the rear side |
| 3 | Retaining bracket for the riser card (not provided at system configuration with Low-Profile cards) | 9 | Card hold down bracket (adjustable for long or short expansion cards; see Figure 17, pos. 2) |
| 4 | Power Supply Unit (PSU) | 10 | Motherboard |
| 5 | Retaining bracket for the riser card (not provided at system configuration with Low-Profile cards) | 11 | Cage for motherboard and expansion cards |
| 6 | Riser card for expansion cards | 12 | Fans (of the fan slide-in-module) |
| | | 13 | Fan slide-in-module with two fans |

Figure 19: ZINC19 2U C236 - Configuration with Low-Profile Cards

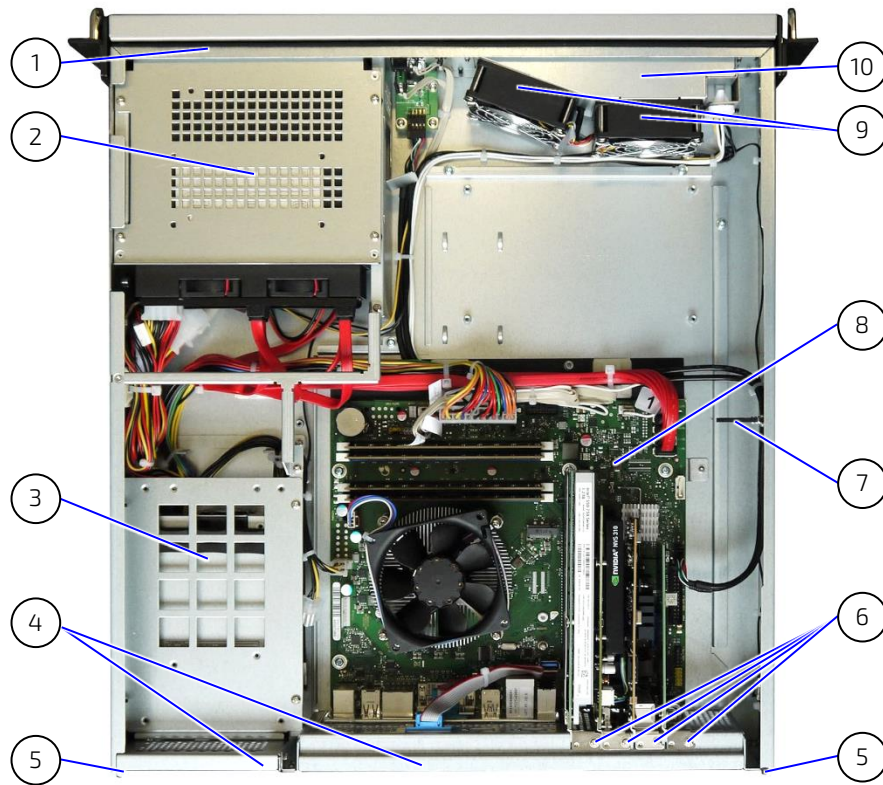

- | | |
|--|--|
| <ul style="list-style-type: none"> 1 Cover retaining plate on the front side 2 Bay1 and Bay2: Drives (stacked one above the other into a drive cage) 3 Power Supply Unit (PSU) 4 Cover retaining plates on the rear side 5 Centering latches for the cover at the rear side | <ul style="list-style-type: none"> 6 Fastening screws for the slot brackets or expansion card slot brackets 7 Card hold down bracket (not used with Low-Profile cards) 8 Motherboard 9 Fans (of the fan slide-in-module) 10 Fan slide-in-module with two fans |
|--|--|

4.4.1. Low-Profile / Riser Card Version and available PCIe Slots

Depending on the ZINC19 2U C236 hardware configuration ordered, you can expand your system with full size and/or half size or Low-Profile additional cards (for slot numbering see Figure 12 and Figure 13).

Table 4: Available PCIe Slots

PCIe Slot				Low-Profile (Slot No.)	Riser Card (Slot No.)
1x	PCIe	x16	16 lanes (PEG)	Yes (2)	Yes (1)
1x	PCIe	x16	4 lanes	Yes (1)	No
1x	PCIe	x1	1 lane	Yes (3)	No
1x	PCIe	x1	1 lane	Yes (4)	No

5/ Installation and Removal

5.1. Attaching the Rubber Feet

If the system is to be used as a desktop version, the rubber feet supplied with the device can be attached to it.

To attach the rubber feet, proceed as follows:

NOTICE

Before attaching the rubber feet, ensure that your system is switched off and disconnected from the main power source.

Ensure that all components are securely installed and that the device cover has been screwed on tightly.

1. Turn the device upside down on a table or desk.
2. Remove the protective film from the rubber feet.
3. Stick the four rubber feet to the underside of the device.

5.2. Cover

The cover will be fixed to the chassis using two fixing brackets at the front side of the cover (Figure 20, pos. 3 and pos. 4), two fixing brackets with captive knurled screws at the rear side of the cover (Figure 20, pos. 7) and the cover fastening knurled screw (Figure 8, pos. 6) at the front side of the ZINC19 2U C236 platform.

When inserting the cover, make sure that:

- ▶ At the front side: the fixing brackets (Figure 20, pos. 4) are inserted properly into the corresponding retaining bracket of the chassis (Figure 18 and Figure 19, pos. 1).
- ▶ At the rear side: the centering latches and the cover retaining plates (Figure 18, pos. 7 and 8, and Figure 19, pos. 4 and 5) are properly inserted into the fixing bracket and centering slots of the cover (Figure 20, pos. 5 and 6).

The centering bracket (Figure 20, pos. 3) and the front cover fastening screw (Figure 8, pos. 6) secure the cover on the front side. The fixing brackets with knurled screws (Figure 20, pos. 7) secure the cover on the rear side.

Figure 20: Inside of the Cover with Fixing Brackets

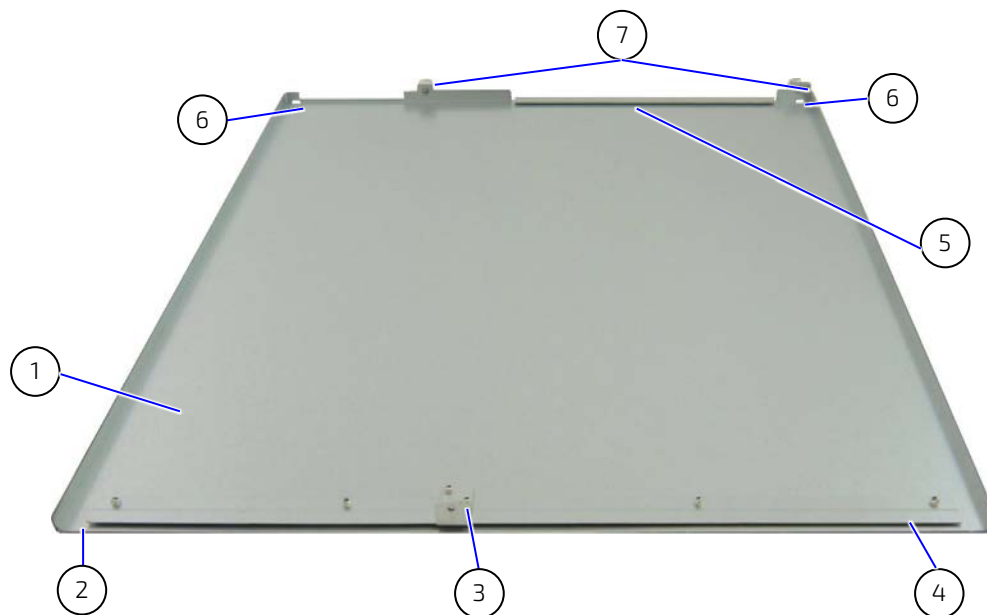

- | | | | |
|---|---|---|-------------------------------------|
| 1 | Inside of the cover | 4 | Fixing bracket (on the front side) |
| 2 | Front part of the cover | 5 | Fixing bracket (on the rear side) |
| 3 | Angled centering bracket with tapped hole (on the front side) | 6 | Centering slots on the cover |
| | | 7 | Fixing brackets with knurled screws |

NOTICE

In order to close the ZINC19 2U C236 platform chassis, ensure that the cover is properly reinstalled and secured with following screws:

- ▶ the cover fastening screw (Figure 8, pos. 6 and Figure 21) on the front side
- ▶ the knurled screws (Figure 12, pos. 5, Figure 13, pos. 5 and Figure 22) on the rear side

5.3. Accessing Internal Components

This section contains important information that you must read before accessing the internal components. You must follow these procedures properly when handling any cards (refer also to the subsection 4.4.1 "Low-Profile / Riser Card Version and available PCIe Slots").

5.3.1. Installing /Removing Expansion Cards

Please consider the following instruction when you install (or remove) expansion cards.

NOTICE

When you install (or remove) expansion cards please consider the corresponding safety instruction of the included "General Safety Instruction for IT Equipment".

The installation and removal of expansion cards have to be carried-out only by qualified specialist personnel in accordance with the description in this manual.

Before removing the device cover, ensure that your system is switched off and disconnected from the mains power supply.



Please refer to the ESD safety procedures for handling assemblies with static sensitive devices.

Failure to take heed of this warning instruction can result in damage to the device.



Please read information provided by the manufacturer of any expansion card before installing them or removing them from your system.

5.3.1.1. Installing /Removing Expansion Cards into ZINC19 2U C236 (Full-Size Cards)

To install or remove an expansion card proceed as follows:

1. Turn your system off and disconnect it from the main power source.
2. Loosen the knurled screws, which secure the cover (refer to Figure 21 and Figure 22).

Figure 21: Loosen the Cover fastening knurled Screw on the Front Side

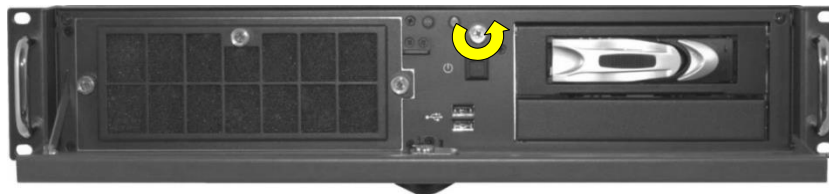

Figure 22: Loosen the knurled Screw on the Rear Side



3. Pull the cover out a little bit (Figure 23) to release the cover centering and fixing brackets (Figure 20, pos. 3 and pos. 4) from the retaining plate of the chassis (see Figure 18, Figure 19, pos. 1) on the front side. At the same time the centering latches and the cover retaining plates (Figure 18, pos. 7 and Figure 19, pos. 5) on the rear side will be removed from the fixing bracket and centering slots of the cover (Figure 20, pos. 5 and 6).

Figure 23: Pulling the Cover backwards



4. Lift the cover up (on the rear edge) and remove it (Figure 24).

Figure 24: Removing the Cover



The motherboard with the corresponding riser card (not in configuration for Low-Profile cards; for Low-Profile cards refer to chapter 5.3.1.2) is mounted on a card cage.

The fastening screws of the slot brackets or expansion card slot brackets can be accessed through holes on the rear left side of the cabinet (see Figure 25).

Figure 25: Mounting an Expansion Card to the Riser Card (not for Configurations with Low-Profile Cards)

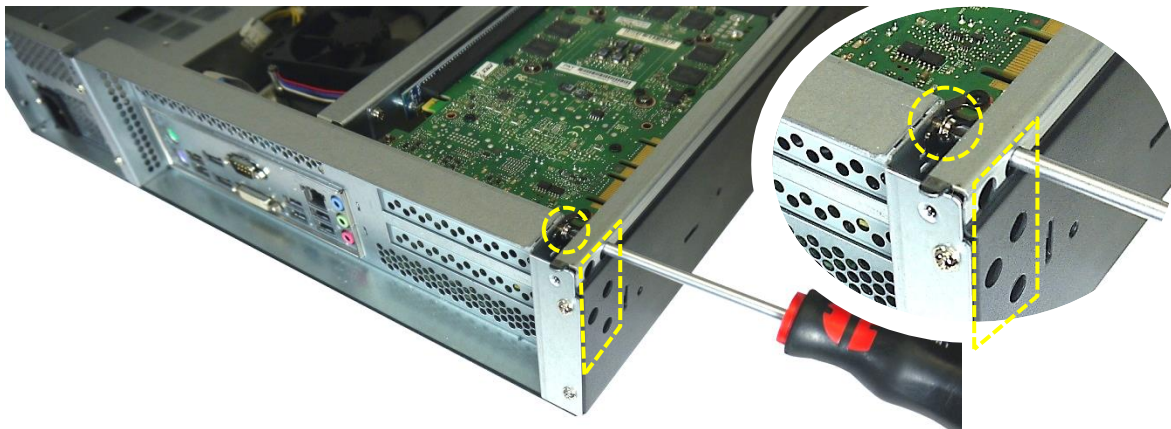

5. Insert/remove the expansion card/s in respectively out from the expansion slot/s of the riser card and fix them to the rear of the card cage. Select the corresponding hole for accessing the fastening screws (see details of Figure 25).
6. Close the system and secure the cover with the knurled screws as described in the section 5.2 "Cover".

5.3.1.2. Installing /Removing Low-Profile Expansion Cards on the Motherboard

To install or remove Low-Profile expansion card in system configuration without riser card proceed as follows:

1. Open the system as described in the subsection 5.3.1.1 (step 1-4).
2. Unscrew the fastening screws of the slot bracket or card slot bracket (Figure 19, pos. 6). Retain the screws for later use.
3. Insert/remove the expansion card/s in respectively out from the expansion slot/s of the motherboard and fix the slot bracket/s of the card/s to the rear of the card cage .
4. Close the system and secure the cover with the knurled screws as described in the section 5.2 "Cover".

5.4. Installation in a 19" Industrial Cabinet



Expansion card installation should be performed before installing the ZINC19 2U C236-system into a 19" industrial cabinet.

Please consider the instructions described in the section 5.3 "Accessing Internal Components".

Before closing the industrial cabinet, you must connect your peripherals to the corresponding system ports.

More information can be found on our web site at www.kontron.com by selecting the product.

CAUTION

Energy hazards > 240 VA are present inside the chassis!

The system has to be mounted and installed only by a qualified service person for this area familiar with the associated dangers.

In order to setting-up, installing / removing the ZINC19 2U C236 system into/from a 19" industrial cabinet, please observe the instructions described in this user's guide.

Please consider the instructions described in the included "General Safety Instructions for IT Equipment".

Please consider the hints included in the subsection 4.2.3 "Power Supply".

Ensure that air flow around the device is adequate when installing the ZINC19 2U C236.

The openings for air intake and exhaust on the device must not be obstructed by objects.

Leave at least 5 cm (approx. 2") of free space to the 19" industrial cabinet in front and behind the ZINC19 2U C236, to prevent the device from possibly overheating.

The 19" industrial cabinet must stand firmly in place. You can improve its stability by placing the components into it from the bottom up. Heavy components should be placed down below.

If further stabilization is necessary, then bolt the 19" industrial cabinet to the floor or anchor it on the wall.

The voltage feeds must not be overloaded.

Adjust the cabling and the external overcharge protection to correspond with the electrical data indicated on the type label.

The type label is located on right side of the unit.

6/ Starting Up

▲WARNING

Please consider the Hints included in the chapter 1/ "General Safety Instructions for IT Equipment".

When used as intended the ZINC19 2U C236 platform is to be operated only closed and locked.

Only when the cover is properly installed, secured with the knurled screws on the rear and the cover fastening screw on the front, and the access panel is locked with the key, it is ensured that the user doesn't have access to the internal parts of the ZINC19 2U C236 platform, loaded with hazardous energy.



The rated voltage of the mains (AC) must agree with the voltage value on the type label.

6.1. AC Power Connection

The AC mains input socket is located on the rear side of the ZINC19 2U C236.

▲CAUTION

Hint for system configuration with AC Wide Range PSU!

Even if you turn off the system using the power button (Figure 8, pos. 7), there is still a standby-voltage of 5 V_{sb} on the motherboard. The unit is completely disconnected from the mains, only when the power cord is disconnected either from the mains or the unit.

Therefore, the power cord and its connectors must always remain easily accessible.



Please observe the settings option for "Restore on AC Power Loss" in the BIOS Setup. Setting options: Always Off, Always ON, Previous State, Disabled.

To connect the power cable, proceed as follows:

1. The ZINC19 2U C236 systems with grounding studs marked with a "Chassis Ground" symbol (Figure 16) have to be grounded appropriately; (refer to the subsection 4.2.4 "Stud for Chassis Grounding").
2. Connect the AC power cord to the AC input connector.
3. Connect the other end of the AC power cord to a corresponding mains outlet.



Use a power cord suitable for the mains power supply in your country.

Make sure that the mains power supply (power outlet) is properly grounded and that the power cord is in perfect condition without any visible damage. An ungrounded power supply is not permissible.

6.2. Operating System and Hardware Components Drivers

The ZINC19 2U C236 system can optionally be supplied with or without a pre- installed operating system.

If you have ordered your system with a pre- installed operating system, all drivers are installed, corresponding to the ordered computer configuration (optional hardware components). Your computer is fully operational, when you switch it on for the first time.

If you have ordered your system without a pre- installed operating system, you have to install the operating system and the corresponding drivers for the ordered computer configuration (optional hardware components).



If required, the drivers for the hardware configuration of your system can be downloaded from the web page www.kontron.com by selecting the product name. The provided drivers have only been tested for the following operating systems: Windows 7 Professional for Embedded Systems and Windows 10 IoT Enterprise.

Consider the manufacturer's specifications for the operating system and the integrated hardware components.

7/ Maintenance and Prevention

Kontron Europe systems only require minimal maintenance and care to keep them operating correctly.

- ▶ Occasionally wipe the system with a soft dry cloth.
- ▶ Remove persistent dirt by use of a soft, slightly damp cloth (only use a mild detergent).
- ▶ Clean the air filter mat regularly (refer to the section 7.2 "Cleaning the Filter Mat").

7.1. Replacing System Fans



Important instructions!

The operation of the ZINC19 2U C236 platform is permitted only with a functional fan slide-in module.

Defective components may be replaced only by Kontron original spare parts.

- ▶ part number of the fan slide-in module: 1050-8442

The fan slide-in module can be changed while the system is powered-on. This maintenance may only be carried out by qualified personnel familiar with the associated dangers

- ▶ No tools required! (Key is required if the front access panel has been locked)

To replace the fan slide-in module, proceed as follows:

1. Remove the air filter mat as described in the section 7.2 "Cleaning the Filter Mat" (step 1 to 3) and put it aside for later use.
2. Loosen the two knurled screws of the fan slide-in module (Figure 26, pos. 1)
3. Pull the fan slide-in module out to disconnect it from the internal fan control socket (Figure 27, pos. 3).
4. Take the slide-in module out of the fan compartment (see Figure 27).

Figure 26: Detail: removing the Fan Slide-In Module

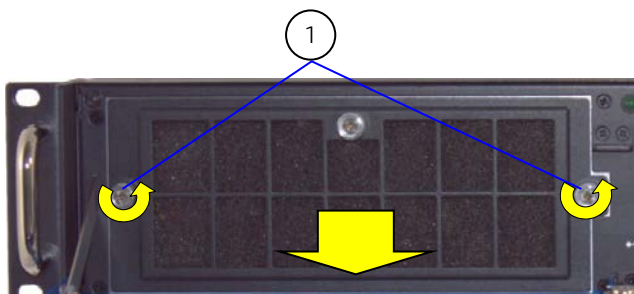
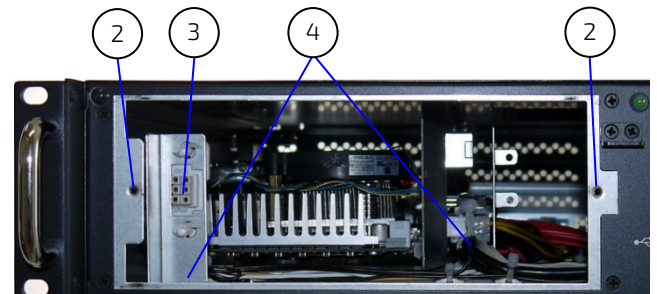

Figure 27: Detail: Fan compartment (without Fan Slide-In Module)



- 1 Fan slide-in module with two knurled screws
- 2 Threaded holes (chassis frame) for securing the fan slide-in module

- 3 Socket for fan power supply and control
- 4 Fan compartment

Figure 28: Fan Slide-In Module without Filter Mat Holder

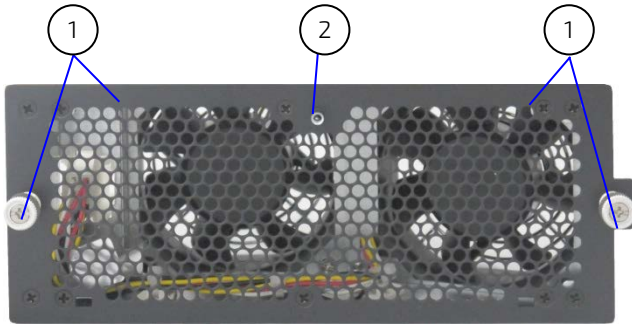

Figure 29: Rear View of the Fan Slide-In Module

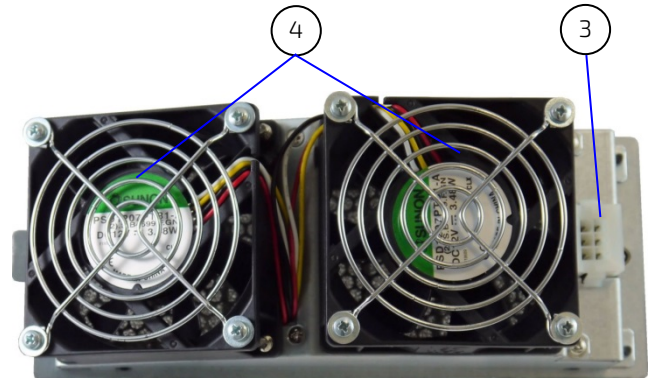
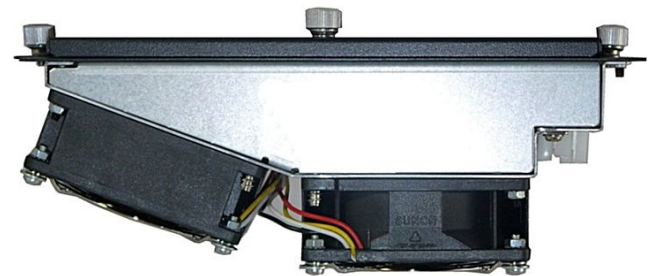

Figure 30: Fan Slide-In Module with mounted Filter Mat Holder



Figure 31: Side View of the Fan Slide-In Module Holder



- | | |
|---|---|
| <ul style="list-style-type: none"> 1 Fan slide-in module with two knurled screws 2 Bolt with tapped hole for mounting the filter mat holder | <ul style="list-style-type: none"> 3 Socket for fan power supply and control 4 2x fans (temperature controlled independently from each other) |
|---|---|

5. Replace the fan slide-in module with a new functional module.
6. Insert the retained filter mat holder (with filter mat) to the front side of the fan slide-in module as described in the section 7.2 "Cleaning the Filter Mat" (step 7 and step 8).
7. Slide the fan slide-in module with mounted filter mat holder (Figure 30) into the fan compartment (Figure 27, pos. 4).
8. Push the fan slide-in module into the fan compartment until the fan control connector (Figure 29, pos. 3) is firmly inserted into the socket (Figure 27, pos. 3).
9. Fasten the knurled screws of the fan slide-in module (Figure 26, pos. 1)

7.2. Cleaning the Filter Mat

The filter mat is inserted in the filter mat holder at the front side of the fan slide-in module (Figure 32, pos. 2). The soiling of the filter mat is caused by the pollution of the operating environment. A heavily soiled filter mat can cause excessive heating of the device. For this reason we recommend to clean the filter mat as often as necessary. The filter mat can be replaced during operation of the system.

Figure 32: Detail with Filter Mat Holder on the Front Side of the ZINC19 2U C236 Platform

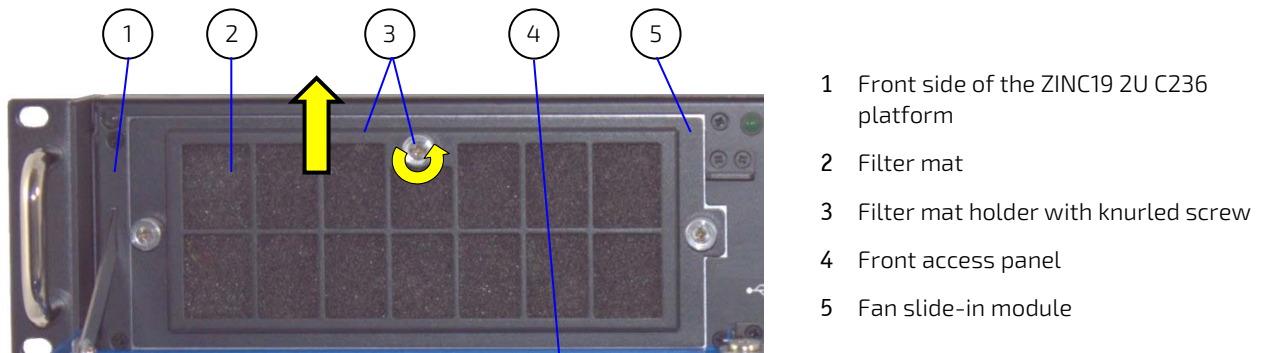

To replace the filter mat, proceed as follows:

1. Open the front access panel (Figure 32, pos. 4).
2. Loosen the knurled screw that secures the filter mat holder to the fan slide-in module (Figure 32, pos. 3 and Figure 34, pos. 5).
3. Pull the filter mat holder out from the positioning holes (Figure 33, pos. 3) in the direction marked with the arrow (Figure 32) and lift it off.
4. Remove the dirty filter mat.
5. Clean the filter mat as follows:
 - ▶ Rinse in water (up to approx. 40°C/104°F; you may add a mild commercial detergent).
 - ▶ It is also possible to beat it, suction clean it or blast it with warm compressed air.
 - ▶ If the filter is soiled with greasy dust, you should rinse it with warm water with degreaser added. Do not clean the air filter mat with a piercing jet of water or wring it out.
6. After cleaning and drying the filter pad, place it in the filter mat holder (see Figure 35).
7. Reattach the filter mat holder to the front side of the fan slide-in module by inserting the positioning latches (Figure 34, pos. 6) into the positioning holes (Figure 33, pos. 3).
8. Fasten the filter mat holder by tightening the knurled screw (Figure 34, pos. 5) to the bolt with tapped hole (Figure 33, pos. 1) at the fan slide-in module.



Defective components may only be replaced by Kontron original spare parts.
Part number of the air filter mat: 1050-8374.

Figure 33: Detail without Filter Mat Holder on the Front Side

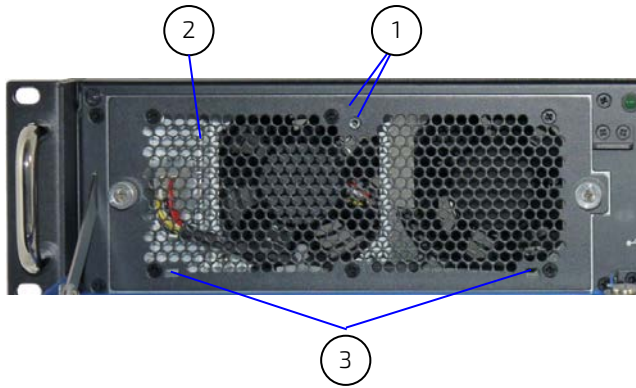

Figure 34: Filter Mat Holder without Filter Mat

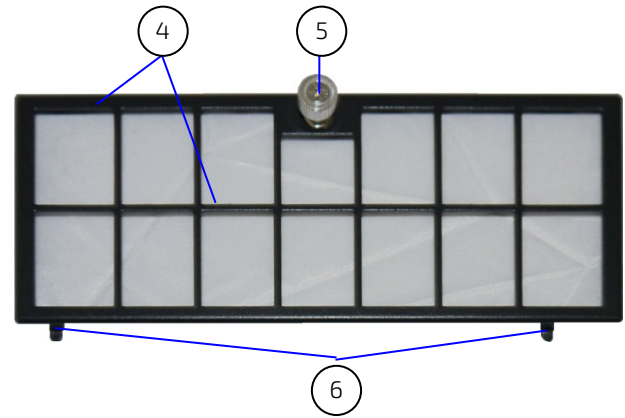

Figure 35: Filter Mat Holder with Filter Mat

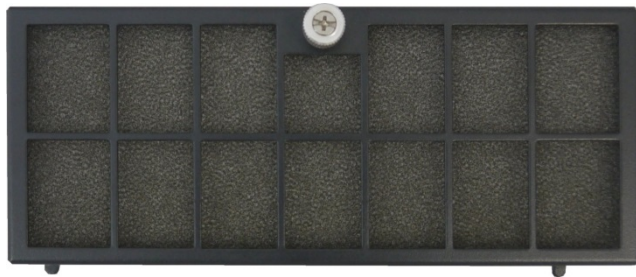

Figure 36: Filter Mat



- 1 Fan slide-in module with tapped hole for knurled screw of filter mat holder
- 2 Air intake openings at the front side of the fan slide-in module

- 3 Positioning holes for the filter mat holder
- 4 Filter mat holder
- 5 Knurled screw of the filter mat holder
- 6 Positioning latches of the filter mat holder

7.3. Replacing the Lithium Battery

Your system's motherboard is equipped with a lithium battery. To replace the lithium battery, proceed as follows:

1. Open the device, as described in the subsection 5.3.1 "Installing /Removing Expansion Cards" (steps 1-4).
2. If you have added expansion cards to your system, first remove the expansion cards and all corresponding connecting cables, to gain access to the lithium battery.
3. Remove the lithium battery from the holder by pulling the ejector spring outwards.
4. Place a new lithium battery in the battery holder.
5. Pay attention to the polarity of the battery.
6. The lithium battery must only be replaced with the same type of battery or with a type of battery recommended by Kontron Europe.
7. Reinstall the removed expansion cards and re-attach the connecting cables.
8. Close the device, as described in the subsection 5.3.1 "Installing /Removing Expansion Cards" (step 10).

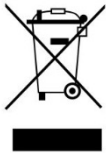

Do not dispose of lithium batteries in general trash collection. Dispose of the battery according to the local regulations dealing with the disposal of these special materials, (e.g. to the collecting points for dispose of batteries).

8/ Mounting

- ▶ The ZINC19 2U C236 is primarily designed to work in an industrial environment built-in in a 19" rack with a minimum depth of 600 mm.
- ▶ The 19" rack must not prevent the ZINC19 2U C236 from drawing air at the front and exhausting air at the rear.
- ▶ There are no mounting restrictions above and beneath the ZINC19 2U C236.
- ▶ To ensure a secure fixation of the ZINC19 2U C236 in a 19" rack, the ears must be screwed to the rack and an additional second fixation, either with slide rails or L-brackets, must be provided.
- ▶ Installation and operating conditions must be considered.

On the left and right sides of the device, there are six M4 threaded screw holes (for M4x6 screws), for installing the ZINC19 2U C236 platform in a 19" industrial cabinet using slide rails.

Figure 37: Threaded holes (M4x6) for mounting the ZINC19 2U C236 System (shown as Left Side View)



Please ensure that only M4x6 screws are used to attach the slide rails to the ZINC19 2U C236.

9/ Technical Data

Table 5: Technical Data

ZINC19 2U C236	
Controls and Indicators (at the front side)	Power button Power LED (green) HDD LED (orange)
Interfaces (at the front side)	2x USB (2.0)
Interfaces (at the rear side)	I/O of the installed motherboard (see 4.2 "Rear Side") * refer to the manual of the installed CPU card (motherboard)
Drives *	2.5" HDD/SSD (removable or fixed) 3.5" HDD (removable or fixed) DVD R/W
Free Expansion Slots *	1x PCIe x16 (16 Lanes, Gen 3) 1x PCIe x16 (4 Lanes, Gen 3) 2x PCIe x1 (1 Lane Gen 3)
Lithium Battery	* refer to the manual of the installed motherboard
Equipped Power Supply Unit	AC Wide Range 100-240V
Rated Voltage Range	See type label

* Depending on system configuration



ZINC19 2U C236 = Type

The "YYYYY-YY-YYYY-Y-Y" group is replaced by up to a max. 13-digit combination of numbers or letters, and represents the system configuration.

9.1. Electrical Specifications

The corresponding electrical specifications of your ZINC19 2U C236 platform can be found on the type label.

9.2. Mechanical Specifications

Table 6: Mechanical specifications

Dimensions	ZINC19 2U C236 (Standard Version)
Height	2U (88 mm) (3.5")
Width	Front: 482 mm (19"); Chassis: 430 mm (16.9")
Depth	Chassis: 472 mm (18.6")
Weight (without packaging)	Approx. 8 kg (17.6 lbs.)
Chassis	Chassis: black (RAL 7021) Front access panel: silver (RAL 9022)

9.3. Environmental Specifications

Table 7: Environmental Specifications

Thermal Management	2x system fan (temperature-controlled) PSU fan CPU Heatsink
Operating Temperature / Relative Humidity	0 ... +50°C (+55°C @ 10% POH per month) (32 ... 122°F (131°F @ 10% POH per month)
Storage / Transport Temperature / Relative Humidity	-20 ... +70°C (-4 ... 158°F)
Humidity (Operating/Storage/Transit)	+40 °C @ 93 % non-condensing
Max. Operation Altitude	3000 m (6560 ft)
Max. Storage / Transport Altitude	10000 m (32810 ft)
Operating Shock	15 G, 11 ms, half sine *
Operating Vibration	10 – 150 Hz, 1.0 G *

* Depending on configuration

9.4. Directives and Standards

Table 8: Directives and Standards

CE Directive	
Electrical Safety	General Product Safety Directive (GPSD) 2001/95/EC Low Voltage Directive (LVD) 2014/35/EU
Electromagnetic Compatibility (EMC)	EMC Directive 2014/30/EU
RoHS II Directives	2011/65/EU

Electrical Safety	Harmonized Standards
EUROPE	Information technology equipment - Safety - Part 1: General requirements EN 60950-1
U.S.A. / CANADA	to meet UL60950-1 / CSA C22.2- No. 60950-1-7
CB Report	to meet IEC 60950-1(ed.2); am1; am2

EMC	Harmonized Standards
EU	Generic emission standard for industrial environments (Emission): EN 61000-6-3 + A1 Generic standards - Immunity for industrial environments (Immunity): EN 61000-6-2

10/ Standard Interfaces – Pin Assignments

Low-active signals are indicated by a minus sign.

10.1. PS/2 Mouse Connector

Table 9: PS/2 Mouse Connector

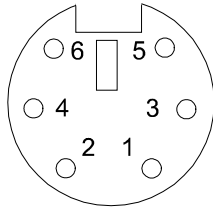
Pin	Signal Name	6-pin Mini-DIN Connector
1	Mouse Data	
2	N.C.	
3	GND	
4	+5 V	
5	Mouse Clock	
6	N.C.	

10.2. PS/2 Keyboard Connector

Table 10: PS/2 Keyboard Connector

Pin	Signal Name	6-pin Mini-DIN Connector
1	Keyboard Data	
2	N.C.	
3	GND	
4	+5 V	
5	Keyboard Clock	
6	N.C.	

10.3. Serial Interface (RS232)

Table 11: Serial Interface (RS232)

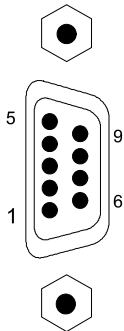
Pin	Signal Name	9-pin D-SUB Connector
1	DCD (Data Carrier Detect)	
2	RXD (Receive Data)	
3	TXD (Transmit Data)	
4	DTR (Data Terminal Ready)	
5	GND (Signal Ground)	
6	DSR (Data Set Ready)	
7	RTS (Request to Send)	
8	CTS (Clear to Send)	
9	RI (Ring Indicator)	

10.4. DisplayPort

Table 12: DisplayPort

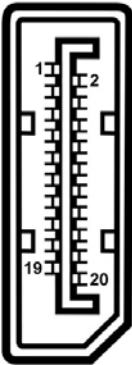
Pin	Signal Name	DisplayPort	Signal Name	Pin
1	ML Lane 0 (p)		GND (ML Lane 0)	2
3	ML Lane 0 (n)		Lane 1 (p)	4
5	GND (ML Lane 1)		Lane 1 (n)	6
7	Lane 2 (p)		GND (ML Lane 2)	8
9	Lane 2 (n)		Lane 3 (p)	10
11	GND (ML Lane 3)		Lane 3 (n)	12
13	AUX SEL#		Pull-down to GND	14
15	AUX CH (p)		GND (AUX CH)	16
17	AUX CH (n)		Hot Plug	18
19	GND (GND_DDC)		3.3V (DDC EEPROM power 500 mA fused)	20

10.5. Ethernet Connector

Table 13: Ethernet Connector

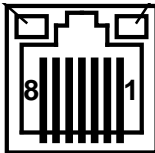
Pin#	Signal Name	X2, X3, X10LAN1, LAN2,LAN3 (RJ45)
1	MDI0+	
2	MDI0-	
3	MDI1+	
4	MDI2+	
5	MDI2-	
6	MDI1-	
7	MDI3+	
8	MDI3-	

10.6. USB 3.0 Port

Table 14: USB 3.0 Port

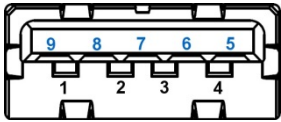
Pin		Signal Name	9-pin USB Connector Type A Version 3.0/2.0
USB 2.0 contact pins		USB 3.0 contact pins	
1	VCC, fused (900 mA max.)	5 StdA_SSRX-	
2	Data-	6 StdA_SSRX+	
3	Data+	7 GND_DRAIN	
4	GND	8 StdA_SSTX-	
		9 StdA_SSTX+	

10.7. USB 2.0 Port

Table 15: USB 2.0 Port

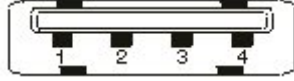
Pin	Signal Name	4-pin USB Connector Typ A Version 2.0
1	VCC	
2	Data-	
3	Data+	
4	GND	

10.8. DVI-D Port

Table 16: DVI-D Port

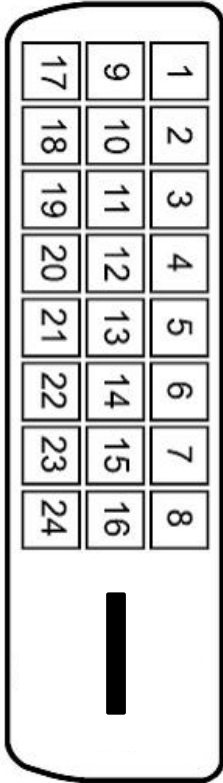
Pin	Signal name	Description	DVI-D connector (female)
1	TMDS2-	Differential TMDS Data 2-	
2	TMDS2+	Differential TMDS Data 2+	
3	GND	TMDS Shield	
4-5	NC	NC	
6	DVI_SCL	DDC EDID data clock	
7	DVI_SDA	DDC EDID data	
8	NC	NC	
9	TMDS1-	Differential TMDS Data 1-	
10	TMDS1+	Differential TMDS Data 1+	
11	GND	TMDS Shield	
12-13	NC	NC	
14	DVI_5V	5 V	
15	GND	Ground	
16	DISPDET	Hot Plug Detection	
17	TMDS0-	Differential TMDS Data 0-	
18	TMDS0+	Differential TMDS Data 0+	
19	GND	TMDS Shield	
20-21	NC	NC	
22	GND	TMDS Shield	
23	TMDSCLK+	Differential TMDS Clock+	
24	TMDSCLK-	Differential TMDS Clock -	



Please observe that the DVI-D connector supports digital signals only.

Appendix A: List of Acronyms

Table 17: List of Acronyms

API	Application Programming Interface
DP	DisplayPort
ESD	Electrostatic Discharge
GND	Ground
NC	Not Connected
PCIe	PCI-Express
PSU	Power Supply Unit
UEFI	Unified Extensible Firmware Interface
VCC	Voltage at common collector (Vcc)



About Kontron

Kontron, a global leader in embedded computing technology and trusted advisor in Internet of Things (IoT), works closely with its customers, allowing them to focus on their core competencies by offering a complete and integrated portfolio of hardware, software and services designed to help them make the most of their applications.

With a significant percentage of employees in research and development, Kontron creates many of the standards that drive the world's embedded computing platforms; bringing to life numerous technologies and applications that touch millions of lives. The result is an accelerated time-to-market, reduced total-cost-of-ownership, product longevity and the best possible overall application with leading-edge, highest reliability embedded technology.

Kontron is a listed company. Its shares are traded in the Prime Standard segment of the Frankfurt Stock Exchange and on other exchanges under the symbol "KBC". For more information, please visit: <http://www.kontron.com/>



CORPORATE OFFICES

EUROPE, MIDDLE EAST & AFRICA

Lise-Meitner-Str. 3-5
86156 Augsburg
Germany
Tel.: + 49 821 4086-0
Fax: + 49 821 4086-111
info@kontron.com

NORTH AMERICA

14118 Stowe Drive
Poway, CA 92064-7147
USA
Tel.: + 1 888 294 4558
Fax: + 1 858 677 0898
info@us.kontron.com

ASIA PACIFIC

1~2F, 10 Building, No. 8 Liangshuihe 2nd Street,
Economical & Technological Development Zone,
Beijing, 100176, P.R. China
Tel.: + 86 10 63751188
Fax: + 86 10 83682438
info@kontron.cn