

KISS 2U

User's Manual
Version 1.02

Kontron Embedded Computers GmbH

0-0096-4034

This page is intentionally left blank.

Table of Contents

Introduction	4
Symbols used in this Manual	5
Important Instructions	6
Warranty Information	6
Exemption from Liability for Accidents	6
Limitation of Liability / Warranty Obligations	6
Safety Instructions	7
Operation of Laser Source Devices	9
Electrostatic Discharges (ESD).....	9
Grounding Methods.....	10
Instructions for the Lithium Battery	10
FCC Statement.....	11
Electromagnetic Compatibility.....	11
Scope of Delivery	12
Optional Components	12
Type Label and Product Identification.....	12
Product Description	13
Front Side.....	15
Controls.....	17
LED Indicators.....	18
Ports on the Front Side	19
Front Access Panel	19
Filter Mat Holder.....	19
Drive Bays.....	20
Rear Side.....	21
System Configurations with SBC Cards (PCI-759/-760/-960)	21
External Ports of the SBC Cards (PCI-759/-760/-960)	22
System Configurations with an 886LCD-M/Flex Motherboard.....	23
External Ports of the 886LCD-M/Flex Motherboard	24
For System Configurations with 986LCD-M/Flex Motherboard	26
External Ports of the 986LCD-M/Flex Motherboard	27
Additional Ports for Configurations with Motherboards.....	30
Power Supply Versions	30

Fan Slide-In Module and Temperature Sensor	31
Side View	31
Integrated Motherboard / SBC Card.....	32
Riser Card and/or Backplane and available Bays.....	33
Installation and Removal.....	34
Attaching the Rubber Feet	34
Accessing Internal Components.....	35
Installing Expansion Cards	35
Installation in a 19" Industrial Cabinet	37
Starting Up.....	39
Connecting the Power Cable and Switching On.....	39
Operating System and Hardware Component Drivers	40
Maintenance and Prevention	41
Replacing System Fans	42
Cleaning the Filter Mat	45
Replacing the Lithium Battery	47
Slide Rails (Option).....	48
Slide Rails Accessories and Assembling.....	49
Installing the Device in an Industrial Cabinet (using Slide Rails)	50
Technical Data.....	51
Power Specification.....	52
Electrical Specifications	53
Mechanical Specifications	53
Environmental Specifications	54
EC Directives and Standards	55
Standard Ports – Pin Assignment	56
Serial port COM1 / 2 / 3 (RS232)	56
Combined PS/2 Keyboard and Mouse Connector.....	56
PS/2 Mouse Connector	57
PS/2 Keyboard Connector	57
Parallel Port (LPT).....	58
VGA Port.....	59
USB Port	59

Technical Support 60
Returning Defective Merchandise..... 61

Introduction

Kontron Embedded Computers would like to point out that the information and instructions contained in this manual may be subject to technical modifications, in particular as a result of continuous product development by Kontron Embedded Computers. The enclosed documents do not contain any assurances on the part of Kontron Embedded Computers as regards the technical processes described or certain product features portrayed in the manual. Kontron Embedded Computers assumes no liability for printing errors or other inaccuracies in this manual, unless it can be demonstrated that Kontron Embedded Computers is aware of such errors or that Kontron Embedded Computers is unaware of these as a result of gross negligence, and that Kontron Embedded Computers has failed to properly correct the errors or inaccuracies for these reasons. Kontron Embedded Computers should like to expressly inform the user that this manual only contains a general description of technical processes and instructions, the implementation of which may not be advisable in their current form in every individual case. In the event of any doubt, you must confer with Kontron Embedded Computers.

This manual is protected by copyright. All rights are reserved by Kontron Embedded Computers. Copies or partial copies of this manual or translations into other languages may not be produced, without the prior written consent of Kontron Embedded Computers. Kontron Embedded Computers should like to point out that the information in this manual will be regularly updated in accordance with technical modifications and additions made to the products by Kontron Embedded Computers and that, consequently, this manual only reflects the technical composition of Kontron Embedded Computers products at the time of going to print.

© 2010 by Kontron Embedded Computers





Reprinting and duplication, even of extracts, is only allowed with the express permission of

Kontron Embedded Computers GmbH

Oskar-von-Miller-Str. 1

85385 Eching

Symbols used in this Manual

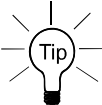
Symbol	Meaning
	This symbol indicates that there is a danger of injury to the user or a risk of damage to the product, should warning notices be disregarded.
	This symbol indicates that the device or parts thereof could be damaged should warning notices be disregarded.
	This symbol refers to general information about the device and the manual.
	This symbol precedes various product configuration details.
	This symbol precedes useful hints and tips for everyday use.

Important Instructions

This chapter contains instructions that must be observed when working with the KISS 2U platform.

The manufacturer's instructions provide useful information on the KISS 2U platform.

Warranty Information

Because of their limited life span, parts that are naturally susceptible to a certain degree of wear and tear (expendable parts) are excluded from the warranty beyond that provided by law. This applies to batteries, for example.

Exemption from Liability for Accidents

Should the user disregard the instructions (specifically the safety instructions) in this manual and possibly on the device, Kontron Embedded Computers will be exempt from legal liability for accidents.

Limitation of Liability / Warranty Obligations

In the event of damage to the device, which is caused by a failure to observe the instructions (specifically the safety instructions) in this manual and possibly on the device, Kontron Embedded Computers will not be required to honour the warranty, including during the warranty period, and will be exempt from legal liability for accidents.



Safety Instructions

Please read this chapter carefully and take note of the instructions for your own safety and proper use of the device.

This chapter also contains information on certification and radio shielding for the system.

Take note of the warnings and instructions on the device and in the manual.

The KISS 2U platform has been built and tested by Kontron Embedded Computers in accordance with EN 60950/VDE 0805 and left the production plant in a perfectly safe condition.

In order to maintain this condition and to guarantee safe operation, the user must observe the instructions and warning notices contained in this manual.

- The device must be used in accordance with the instruction manual.
- The electrical wiring in the related rooms must meet the requirements of the applicable regulations.
- Ensure that no cables, in particular power cables, are lying across the floors in accessible areas, where people could fall over or get caught in them.
- Avoid using power cables in sockets with a large number of other devices. Do not use extension cables.
- Only use the power cable supplied with the device.
- Do not position the device close to a heat source or in a damp place. Ensure that the device has adequate ventilation.
- Only devices or components, which meet the requirements of a SELV circuit (safety extra-low voltage) in accordance with EN 60950, should be connected to the system ports.
- Switching off the device using the power on/off button does not disconnect the computer from the power source. The device is only completely isolated from the mains by disconnecting the mains power cable from the mains or from the device.

For this reason, ensure that there is easy access to the mains power cable, including its mains plug.

- ❑ All plugs on connection cables must be screwed or bolted to the chassis.
- ❑ The device should only be operated in a horizontal position.
- ❑ The device should only be maintained or repaired by specialists authorised by Kontron Embedded Computers, who are aware of the associated dangers.
- ❑ The device should only be opened for the installation and removal of PCI-/PCIe x16- /PCIe x4 expansion cards, in accordance with the description in this manual. These operations should only be undertaken by qualified specialists.
- ❑ When expanding the device, care must be taken to comply with legal regulations as well as technical specifications.
- ❑ The device must be switched off and disconnected from the power source, before installing an expansion card.
- ❑ Only original accessories approved by Kontron Embedded Computers should be used.
- ❑ It must be assumed that safe operation is no longer possible,
 - when the device displays visible signs of damage, or
 - when the device no longer works.In such cases, the device must be turned off and secured against unintentional operation.

Operation of Laser Source Devices



Fig. 1: Laser radiation warning sticker

The optional CD and DVD drives contain light-emitting diodes (classified in accordance with IEC 825-1:1993: LASER CLASS 1) and must therefore not be opened.

When the drive housing is open, invisible laser radiation is emitted. Do not expose yourself to the laser beam.

The laser system meets the requirements of Federal Regulations 21 CFR, 1040 in the USA and the Canadian Radiation Emitting Devices Act pursuant to REDR C 1370.



Electrostatic Discharges (ESD)

A sudden electrostatic discharge can destroy sensitive components. Proper packaging and earthing rules must therefore be observed. Always take the following precautions.

1. Transport boards and cards in electrostatically secure containers or bags.
2. Keep electrostatically sensitive components in their containers, until they arrive at an electrostatically protected workplace.
3. Only touch electrostatically sensitive components when you are properly earthed.
4. Store electrostatically sensitive components in protective packaging or on anti-static mats.

Grounding Methods

The following measures help to avoid electrostatic damages to the device:

1. Cover workstations with approved antistatic material. Always wear a wrist strap connected to workplace as well as properly grounded tools and equipment.
2. Use antistatic mats, heel straps, or air ionizers for more protection.
3. Always handle electrostatically sensitive components by their edge or by their casing.
4. Avoid contact with pins, leads, or circuitry.
5. Turn off power and input signals before inserting and removing connectors or connecting test equipment.
6. Keep work area free of non-conductive materials such as ordinary plastic assembly aids and styrofoam.
7. Use field service tools such as cutters, screwdrivers, and vacuum cleaners which are conductive.
8. Always place drives and boards PCB-assembly-side down on the foam.

Instructions for the Lithium Battery

The installed motherboard or SBC card is equipped with a Lithium battery (depending on the system configuration ordered). For the replacing of this battery please observe the instructions described in the **“Fehler! Verweisquelle konnte nicht gefunden werden.”** chapter.



Warning

Danger of explosion when replacing with wrong type of battery. Replace the battery only with UL listed Lithium battery that has the same or equivalent type recommended by Kontron



Do not dispose of lithium batteries in general trash collection. Dispose of the battery according to the local regulations dealing with the disposal of these special materials, (e.g. to the collecting points for dispose of batteries).

FCC Statement

This device has been tested and found to comply with the limits for a Class A digital device, pursuant to Part 15 of the FCC Rules. These limits are designed to provide reasonable protection against harmful interference when the device is operated in commercial environment. This device generates, uses, and can radiate radio frequency energy and, if not installed and used in accordance with the instruction manual, may cause harmful interference to radio communications. Operation of this device in residential areas is likely to cause harmful interference in which case the user will be required to correct the interference at his own expense.

(English): This Class A digital apparatus complies with the Canadian ICES-003.

(French): Cet appareil numérique de la classe A est conforme à la norme NMB-003 du Canada.

Electromagnetic Compatibility

This device has been developed for industrial, commercial and office use, as well as for small businesses. It is governed by Electromagnetic Compatibility Guideline 89/336/EEC in its currently applicable version and/or by German Electromagnetic Compatibility legislation. Should the user make changes and/or add to the device (e.g. installation of expansion cards), the requirements for the EC Declaration of Conformity (protective requirement) may no longer be met.

Scope of Delivery

- KISS 2U platform (with the system configuration ordered)
- Two keys for the front panel lock
- AC power cord
- Rubber feet (self-adhesive)

Optional Components

- Slide rails

Type Label and Product Identification

The type label for the KISS 2U platform is located on the right side of the device.

Product Designation	Product Identification
KISS 2U 759-A/B	KISS 2U with PCI-759 SBC card (Single Board Computer)
KISS 2U 760-A/B	KISS 2U with PCI-760 SBC card (Single Board Computer)
KISS 2U 960-A/B	KISS 2U with PCI-960 SBC card (Single Board Computer)
KISS 2U 886LCD-A/B	KISS 2U with 886LCD-M/Flex motherboard
KISS 2U 986LCD-A/B	KISS 2U with 986LCD-M/Flex motherboard

Note on product designation:

A: Denotes systems with a wide range AC power supply

B: Denotes systems with a redundant wide range AC power supply

Product Description

KISS 2U is a scalable 2U (19") platform, which can be fitted with either a motherboard or a single board computer (SBC) and which thereby supports different system configurations. The flexible customer-specific hardware system configuration and robust design with excellent mechanical stability provides the KISS 2U platform with the necessary characteristics for a computer, which is suitable for use in harsh industrial environments.

The KISS 2U platform is available as a 19" rack device and as a desktop version.

KISS 2U Platform Versions:

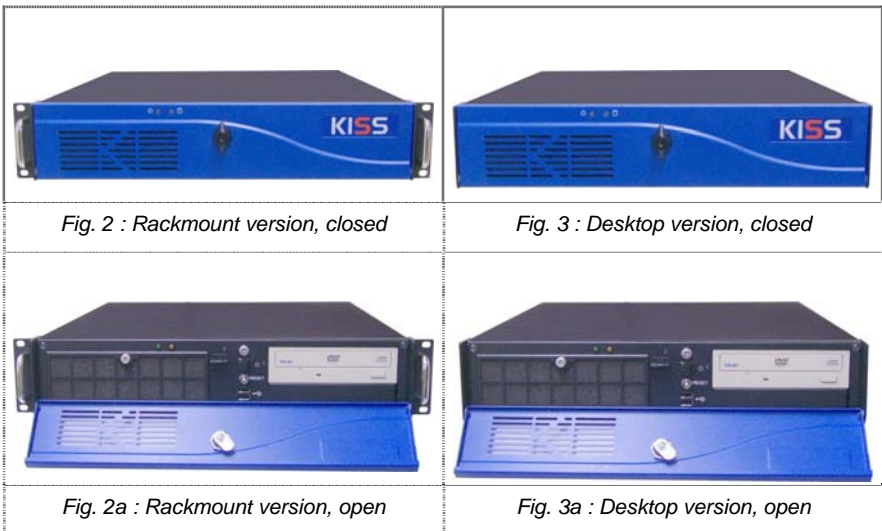

The device can be fitted with a wide range or a redundant AC power supply (depending on the system configuration ordered).

The controls for the KISS 2U platform are located behind the front access panel and consist, as standard, of a Power On/Off button and a Reset button. The power supply switch is on the rear side of the device (for system configurations with wide range power supplies only).

The indicators are located on the front of the device: These comprise a “Power LED” and a “Hard disk activity LED” as standard.

The system fans mounted on the front of the device are built into the device using a fan slide-in module. The fan slide-in module simplifies the installation and removal of these components, even during operation.

The washable filter mat, which protects the system from dirt, is located at the front of the device. It is possible to change the filter mat during operation of the KISS 2U platform.

Depending on the integrated AC power supply (wide range or redundant), various drive bays are available:

The name plate is located on the right hand side of the device.

The integrated AC power supply with the power supply On/Off switch is on the back of the device.



Fig. 4: KISS 2U platform



When switching on the KISS 2U platform, ensure that the ventilation slots are not obstructed.

Front Side

The KISS 2U platform is available as a rackmount version.

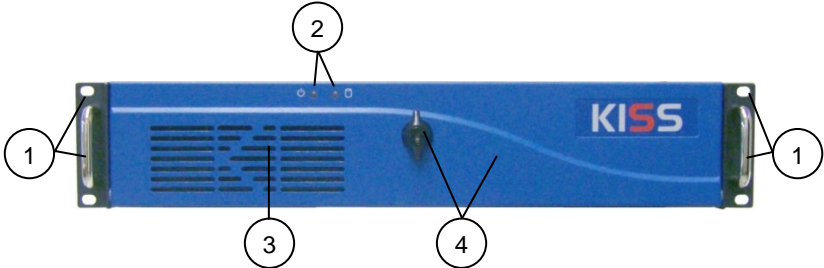
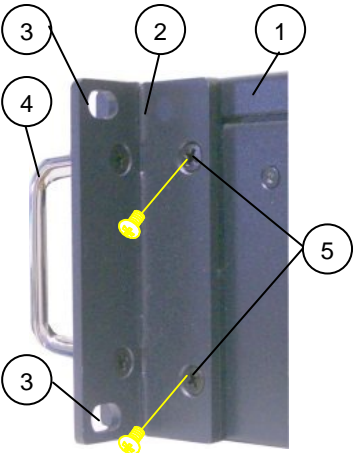

Fig. 5: Front (rackmount version) with the front access panel closed

- 1 19" bracket with handle
- 2 Light diffusers for HDD and Power LEDs
- 3 Ventilation grille on the front access panel
- 4 Front access panel with a locking mechanism

You can very easily convert your system to a desktop version. To do this, unscrew the left and right hand 19" brackets from the device. To attach the rubber feet (included), proceed as described in the "Attaching the Rubber Feet" chapter.



- 1 KISS 2U platform chassis
- 2 19" bracket with handle
- 3 Anchor points for installation in an industrial cabinet
- 4 Handle
- 5 Screws for attaching the 19" bracket

Fig. 6: 19" bracket with fixing screws

Product Description

The controls (Power On/Off and Reset buttons), USB ports and the integrated 5.25" drive are located on the front of the KISS 2U platform, behind the front access panel.

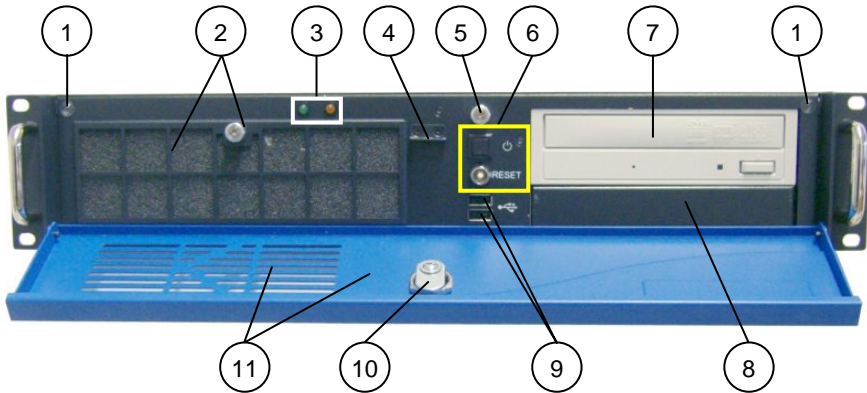

Fig. 7: Front (rackmount version) with the front access panel open

- | | | | |
|---|--------------------------------------|----|--|
| 1 | Bump stop for the front access panel | 7 | 1x 5.25" externally accessible drive bay (shown here with an integrated DVD drive) |
| 2 | Filter mat holder with fixing screw | 8 | 1x internal 3.5" drive bay |
| 3 | Indicators | 9 | 2x USB (2.0) ports |
| 4 | Slot for the locking mechanism | 10 | Locking mechanism |
| 5 | Knurled screw for securing the cover | 11 | Front access panel with ventilation grille |
| 6 | Controls | | |

Controls



Fig. 8: Controls on the front

Power On/Off Button Press this button to switch the system on or off.

Reset Button If your system no longer reacts, you need to restart the KISS 2U platform. Press the reset button to restart your system



When a reset is performed, all data is erased from the internal memory. The system restarts, without the need to switch the computer off and on again.



Even when you switch the system off using the Power On/Off button, there is still standby power of 5 V to the SBC card and/or the motherboard.

Switching off the device using the Power On/Off button does not disconnect the computer from the power source. The device is only fully disconnected:

- when you disconnect the power cable from the power source or from the device

or

- when you turn the power switch of the PSU to "Off".

For this reason, ensure that there is easy access to the power cable, including its plug.

LED Indicators

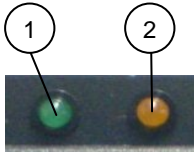

- | | |
|---|---------------------------------------|
| 1 | Power LED (green) |
| 2 | Hard disk drive activity LED (orange) |

Fig. 9: Indicators

The LED indicators are located in the top left corner on the front of the device.

LED indicators	
Power LED (green)	This LED is green when the system is switched on using the Power On/Off button. Requirement: The system must be connected to the appropriate power source, using the mains power cable. The power supply on/off button, on the back of the system must be set to “On”.
Hard drive activity LED (orange)	This LED is orange when the hard disk is being accessed.



Do not press the eject button, while the drive LED is lit or flashing.

Ports on the Front Side

USB Ports

KISS 2U has two USB (2.0) ports on the front (depending on the system configuration ordered). Various USB-compatible peripherals can be connected to these ports.

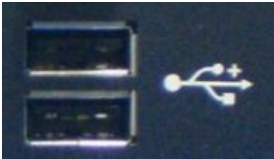

Fig. 10: USB ports on the front

Front Access Panel

The front access panel is fitted with a safety lock. The drives and controls for your KISS 2U platform, which can be accessed from the outside, are protected against unauthorised use.



When USB devices are connected to the USB ports on the front of the device, the front access panel cannot be closed and locked.



The key has to be stored in a manner that renders it inaccessible to unauthorised personnel.

The KISS 2U platform is supplied with two keys. Should the keys be lost or damaged, the front access panel can only be opened by Kontron Embedded Computers service personnel.

Filter Mat Holder

The filter mat holder is located behind the ventilation grille on the front access panel. The filter mat is placed in the filter mat holder. This mat protects your system from dust and dirt (refer to “Cleaning the Filter Mat” chapter).

Drive Bays

Depending on the integrated AC power supply (wide range or redundant), the following drive bays are available:

Available Drive Bays	KISS 2U	
	With a wide range power supply unit	With a redundant power supply unit
3.25" internal	<input checked="" type="checkbox"/>	Not available
5.25" external accessible	<input checked="" type="checkbox"/>	
3.25" internal or external accessible	<input checked="" type="checkbox"/>	
	<input type="checkbox"/> for an internal 3.5" SATA hard disk or <input type="checkbox"/> for a 3.5" hot swap module (external accessible) for 2x 2.5" removable SATA hard disks or <input type="checkbox"/> for an external accessible slim drive	



The 3.5" hot swap module allows you to replace the SATA hard disk during operation.

Rear Side

On the rear side, depending on the ordered KISS 2U platform configuration, are available the external interfaces of the integrated motherboard or SBC-board, the additional interfaces (only in system configuration with SBC-board), the power supply unit and the air exhaust openings.



The order or the number of the KISS 2U platform interfaces can be different depending on the device configuration.

System Configurations with SBC Cards (PCI-759/760/960)

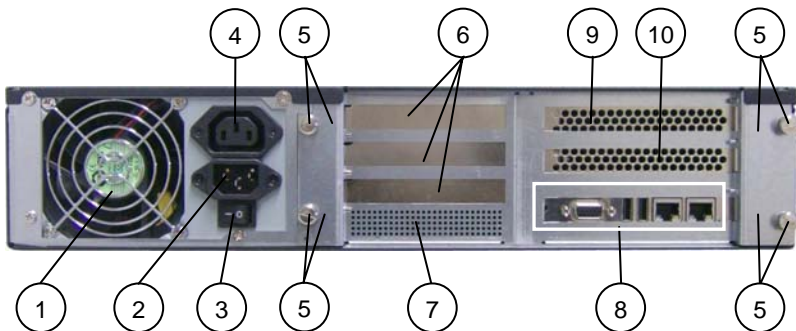

Fig. 11: Rear side of the KISS 2U with an SBC card (here with a wide range power supply)

- | | |
|---|---|
| 1 Fan of the power supply unit (PSU) | 7 Air exhaust openings |
| 2 AC connector | 8 Interfaces of the SBC card (PCI-759, PCI-760 or PCI-960) |
| 3 “On/Off” power supply switch (for wide range power supply only) | 9 Free card slots: |
| 4 AC socket for connecting a monitor (for wide range PSU only) | <ul style="list-style-type: none"> • 32 bit PCI slot, half size for PCI-759 SBC • PCIe x16 for PCI-760 or PCI-960 SBC |
| 5 Board and additional card cage with fixing screws | 10 Free card slots: |
| 6 Free card slots: | <ul style="list-style-type: none"> • PCIe x4 slot for PCI-760 or PCI-960 SBC |
| 32 bit PCI, full size | |

External Ports of the SBC Cards (PCI-759/-760/-960)



A detailed ports description can be found in the manual for the PCI-759, PCI-760 or PCI-960 SBC card. You can download the corresponding manual from our web site www.kontron.com by selecting the product.

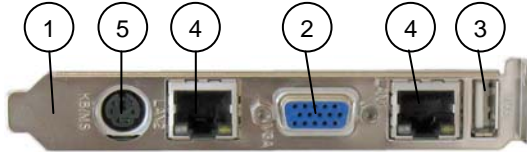

Fig. 12: External ports of PCI-759 SBC card

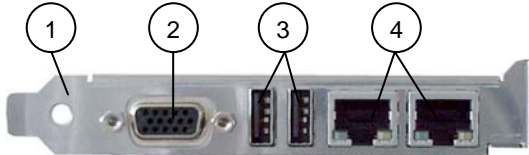

Fig. 12a: External ports of PCI-760 and PCI-960 SBC card

Legende for Fig. 12 and 12a:

- | | |
|----------------------------------|---|
| 1 PCI-759/-760/-960 slot bracket | 4 2x LAN ports with integrated LEDs |
| 2 VGA port | 5 Combined PS/2 keyboard and mouse port |
| 3 2x USB (2.0) ports | |

VGA Port

This interface connector is provided as a 15-pin D-SUB socket and allows the connection of an external (analog) monitor.

USB 2.0 Ports

Different USB peripherals can be connected to these ports.

LAN Ports

These ports are provided as RJ45 connectors with integrated LEDs and support a data transfer rate of 10/100/1000Mbps.

Combined PS/2 Keyboard and Mouse Connector

To this PS/2 connector, provided as a 6-pin mini DIN connector (female) you can connect:

- a PS/2 mouse (by use of an Y adapter cable only) or
- a PS/2 keyboard or
- a PS/2 mouse and a PS/2 keyboard (by use of an Y adapter cable only)

System Configurations with an 886LCD-M/Flex Motherboard

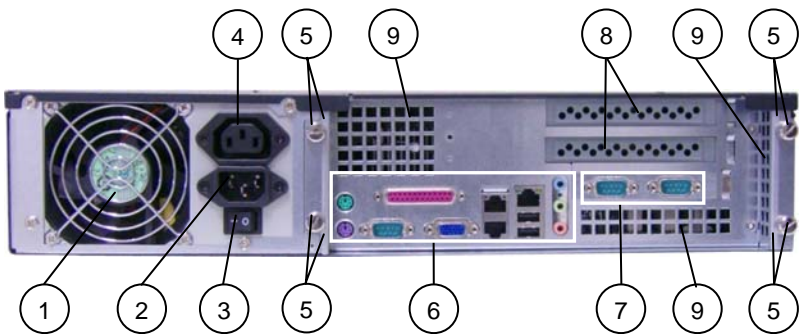

Fig. 13: Rear side of the KISS 2U with an 886LCD-M/Flex (here with a wide range power supply)

- | | |
|---|---|
| 1 Fan of the Power Supply Unit (PSU) | 6 Port for the 886LCD-M/Flex motherboard |
| 2 AC connector | 7 Additional serial ports (RS232) |
| 3 "On/Off" PSU switch
(for wide range PSU only) | 8 Free card slots:
32 bit PCI, full size |
| 4 AC sockets for connecting a
monitor
(for wide range PSU only) | 9 Air exhaust openings |
| 5 Board and expansion card cage
with fixing screws | |

External Ports of the 886LCD-M/Flex Motherboard



A detailed ports description can be found in the manual for the 886LCD-M/Flex motherboard. You can download the corresponding manual from our web site www.kontron.com by selecting the product.

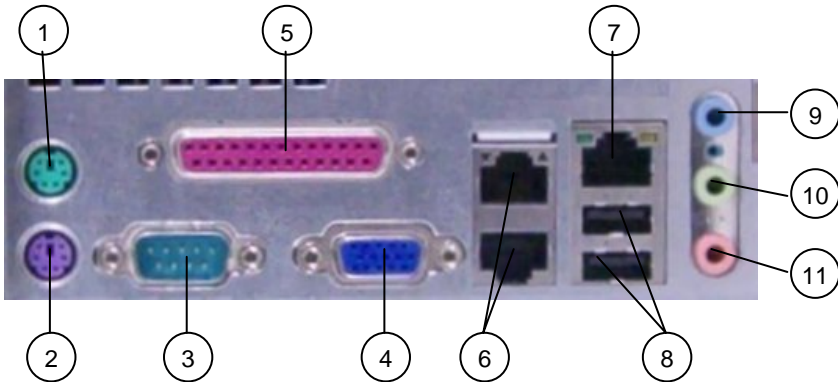

Fig. 14: External ports of the 886LCD-M/Flex motherboard

- | | |
|--|---|
| 1 PS/2 mouse port (green) | 7 1x Ethernet ports (RJ45), with integrated LEDs (10/100Mbps) |
| 2 PS/2 keyboard port (purple) | 8 2x USB(2.0) ports |
| 3 Serial port (RS232) | 9 Line-In connection (blue) |
| 4 VGA port | 10 Line-Out connection (green) |
| 5 Parallel port (LPT) | 11 Microphone connection (pink) |
| 6 2x Ethernet ports (RJ45), without integrated LEDs (10/100Mbps) | |

PS/2 Mouse Connector

You can connect a PS/2-compatible mouse to the Mini-DIN connector.

PS/2 Keyboard Connector

You can connect a PS/2-compatible keyboard to the Mini-DIN connector.

Serial Port

The port is provided as a 9-pin D-SUB connector; it is RS232 configured and allows the connection of a serial peripheral.

VGA Port

This interface connector is provided as a 15-pin D-SUB socket and allows the connection of an external (analog) monitor.

Parallel Port

This connector is available as a 25-pin D-SUB socket. The LPT parallel interface supports different modes: SPP, EPP and ECP.

It is used for connecting an external printer and can also be used for other external devices which can be connected via the parallel port. Depending on the device, the manufacturer's instructions must be observed and the necessary software drivers installed.

USB 2.0 Ports

Different USB peripherals can be connected to these ports.

Line-Out/ Line-In/ Microphone Connection

These jack connectors (3.5 mm) can be used to connect speakers/headphones (Line-Out), audio devices (Line-In) and microphones (Mic-In). The 886LCD-M/Flex motherboard supports 2-channel audio output.

LAN Ports

Two of these ports are provided as RJ45 connectors without integrated LEDs. The third is an Ethernet connection consisting of RJ45 connector with integrated LEDs. All three LAN ports support a data transfer rate of 10/100Mbps.

For System Configurations with 986LCD-M/Flex Motherboard

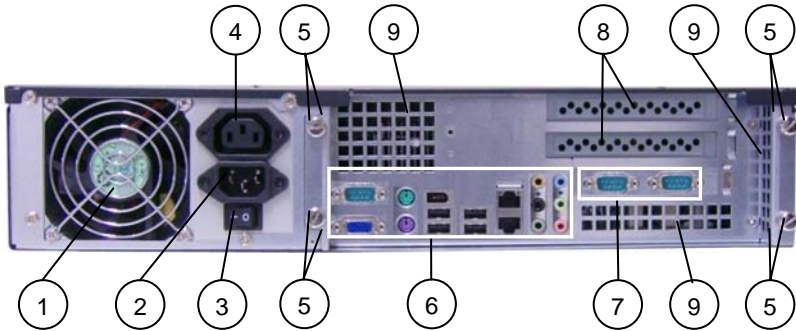

Fig. 15: Rear Side of the KISS 2U with a 986LCD-M/Flex (here with a wide range power supply unit)

- | | |
|---|---|
| 1 Fan of the Power Supply Unit (PSU) | 6 Ports of the 986LCD-M/Flex motherboard |
| 2 AC connector | 7 Additional serial ports (RS232) |
| 3 "On/Off" PSU switch
(for wide range PSU only) | 8 Free card slots:
32 bit PCI, full size |
| 4 AC socket for connecting a monitor
(for wide range PSU only) | 9 Air exhaust openings |
| 5 Board and expansion card cage
with fixing screws | |

External Ports of the 986LCD-M/Flex Motherboard



A detailed ports description can be found in the manual for the 986LCD-M/Flex motherboard. You can download the relevant manual from our web site www.kontron.com by selecting the product.

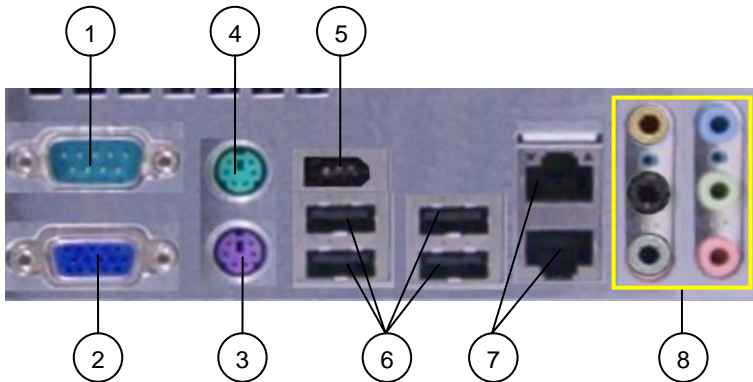

Fig. 16: External port of the 986LCD-M/Flex motherboard

- | | | | |
|---|-----------------------------|---|---|
| 1 | Serial port (RS232) | 6 | 2x USB (2.0) ports |
| 2 | VGA port | 7 | 2x Ethernet ports (RJ45), without integrated LEDs (10/100/1000Mbps) |
| 3 | PS/2 keyboard port (purple) | 8 | Audio connection |
| 4 | PS/2 mouse port (green) | | |
| 5 | IEEE 1394 port (Firewire) | | |

Serial Port

The port is provided as a 9-pin D-SUB connector; it is RS232 configured and allows the connection of a serial peripheral.

VGA Port

This interface connector is provided as a 15-pin D-SUB socket and allows the connection of an external (analog) monitor.

PS/2 Mouse Connector

You can connect a PS/2-compatible mouse to the Mini-DIN connector.

PS/2 Keyboard Connector

You can connect a PS/2-compatible keyboard to the Mini-DIN connector.

IEEE 1394 Port (Firewire)

The port is provided as a 6-pin connector. Different IEEE 1394-compatible peripherals can be connected to this port.

USB 2.0 Ports

Different USB peripherals can be connected to these four ports.

LAN Ports

These ports are provided as RJ45 connectors without integrated LEDs and support a data transfer rate of 10/100/1000Mbps.

Audio Connections

For 2-channel audio output support:

Colour of the audio connection [Jack connectors (3.5 mm)]	2-channel	Connection
Blue	Line-In	for an audio device
Green	Line-Out	for speakers/headphones
Pink	Mic-In	for a microphone

For 4, 6 or 8-channel audio output support:

Colour of the audio connection	4-channel	6-channel	8-channel
Blue	Line-In	Line-In	Line-In
Green	Front speaker out	Front speaker out	Front speaker out
Pink	Mic-In	Mic-In	Mic-In
Orange	-	Center/Subwoofer	Center/Subwoofer
Black	Rear speaker out	Rear speaker out	Rear speaker out
Gray	-	-	Side speaker out

Additional Ports for Configurations with Motherboards

Serial Ports (RS232)

The KISS 2U with 886LCD-M/Flex and 986LCD-M/Flex motherboards have two additional serial ports (RS232) on the rear side of the system (see *Fig. 13* and *Fig. 15, pos. 7*). The port is provided as a 9-pin D-SUB connector; it is RS232 configured and allows the connection of serial peripheral.



For more information and technical data, please refer to the corresponding motherboard manual. You can download the manual from our web site www.kontron.com by selecting the product.

Power Supply Versions

The power supply unit is located on the rear side of the KISS 2U platform.

Every KISS 2U platform can be equipped with either a wide range or a redundant wide range AC power supply unit.

The particular power supply version and the power supply voltage can be seen on the type label, which is attached to the right side of the device.

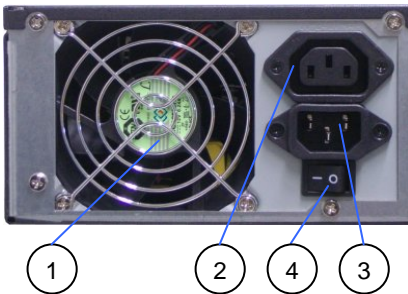

Fig. 17: Wide range PSU detail

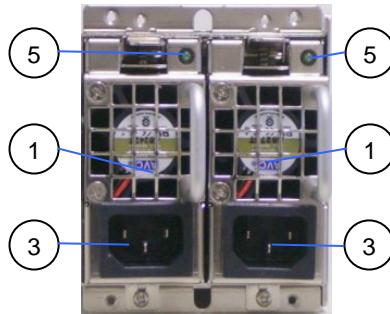

Fig. 17a: Redundant wide range PSU detail

- | | |
|--------------------------------------|---|
| 1 Fan of the power supply unit (PSU) | 4 PSU switch |
| 2 Monitor connection | 5 Power LED (for redundant power supply only) |
| 3 AC connection | |

Fan Slide-In Module and Temperature Sensor

The three system fans are securely installed in a user-friendly, interchangeable fan-slide-in module (Hot-Swap). The fan slide-in module is mounted in the fan compartment on the front of the device.

The systems fans are temperature-controlled via the temperature sensors which are built in the system. Thus sufficient airflow is ensured for an optimal, active cooling of the system.



The operation of the KISS 2U platform is permitted only with a functional fan slide-in module (refer to the “Replacing System Fans” section).

Defective components may be replaced only by Kontron original spare parts.

❑ part number of the fan slide-in module: 1009-1642

Side View

On the left and right sides of the device, there are four M4 threaded screw holes, for installing the KISS 2U platform in a 19" industrial cabinet using slide rails [not included; refer to the chapter “Slide Rails (Option)”].

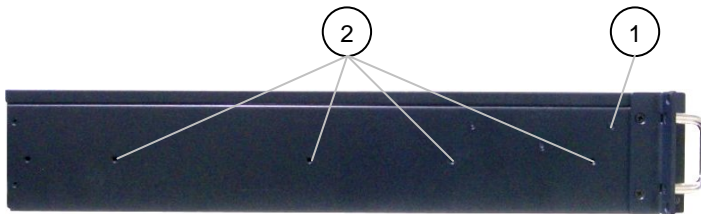

Fig. 18: Threaded screw holes (M4) for attaching slide rails

- 1 Side view of the KISS 2U platform 2 4x M4 threaded screw holes (on both sides)

Integrated Motherboard / SBC Card

Depending on the KISS 2U platform configuration ordered, your system may be fitted with a motherboard or an SBC card (Single Board Computer).

System Designation	Integrated Board	Board Type
KISS 2U 886LCD-A/B	886LCD-M/Flex	Motherboard
KISS 2U 986LCD-A/B	986LCD-M/Flex	Motherboard
KISS 2U 759-A/B	PCI-759	PICMG 1.0 SBC card
KISS 2U 760-A/B	PCI-760	PICMG 1.3 SBC card
KISS 2U 960-A/B	PCI-960	PICMG 1.3 SBC card



Fig. 19: 886LC-M/Flex motherboard



Fig. 19a: 986LC-M/Flex motherboard



*Fig. 19b: PCI -759
SBC card*



*Fig. 19c: PCI -760
SBC card*

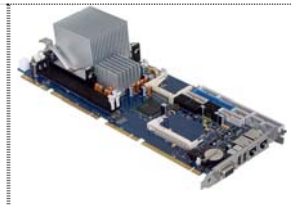

*Fig. 19d: PCI -960
SBC card*



More information and technical data can be found in the corresponding board manual (motherboard or SBC, depending on the system configuration ordered).

You can download the manual from our web site at www.kontron.com by selecting the product.

Riser Card and/or Backplane and available Bays

Depending on the KISS 2U hardware configuration ordered, you can expand your system with full size and/or half size additional cards.



When equipping your system with expansion cards, pay attention to the power specification appearing in the “Technical Data” chapter and ensure that the power consumption per card does not exceed 25 W.

System	Integrated Board	Available Slots for Expansion Cards
KISS-2U	886LCD-M/Flex	2x PCI, 32 bit @ 33 MHz, full size
	986LCD-M/Flex	2x PCI, 32 bit @33 MHz, full size
	PCI-759 (PICMG1.0)	3x PCI, 32 bit @33 MHz, full size 1x PCI, 32 bit @33 MHz, half size
	PCI-760 (PICMG1.3)	3x PCI, 32 bit @33 MHz, full size 1x PCIe x16 1x PCIe x4
	PCI-960 (PICMG1.3)	3x PCI, 32 bit @33 MHz, volle Länge 1x PCIe x16 1x PCIe x4

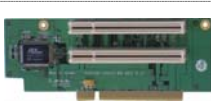

Fig. 20: Riser card for 886LC-M/Flex



Fig. 20a: Riser card for 986LCD-M/Flex



Fig. 20b: PICMG 1.0 Butterfly backplane for PCI-759SBC card



Fig. 20c: PICMG 1.3 Butterfly backplane for PCI-760/-960 SBC card

Installation and Removal

Attaching the Rubber Feet

If the system is to be used as a desktop version, the rubber feet supplied with the device can be attached to it.

To attach the rubber feet, proceed as follows:



Before attaching the rubber feet, ensure that your system is switched off and disconnected from the power source.

1. Ensure that all components are securely installed and that the device cover has been screwed on tightly.
2. Turn the device upside down on a table or desk.
3. Remove the protective film from the rubber feet.
4. Stick the four rubber feet to the underside of the device.

Accessing Internal Components

This section contains important information that you must read before accessing the internal components. You must follow these procedures properly when handling any boards or replacing the fan slide in module.

Installing Expansion Cards

Please consider following instruction when you install (or remove) expansion cards.



The installation and removal of expansion cards have to be carried-out only by qualified specialist personnel in accordance with the description in this manual.

Before removing the device cover, ensure that your system is switched off and disconnected from the mains power supply.

When expand your system with additional cards, please observe the power consumption specification specified in the “Technical Data” chapter and that each additional card does not exceed 25 W power consumption.



Please refer to the ESD safety procedures for handling assemblies with static sensitive devices.

Failure to take heed of this warning instruction can result in damage to the device.



Please read information provided by the manufacturer of any expansion cards before installing them or removing them from your system.

To install or remove an expansion card proceed as follows:

1. Switch your system off and disconnect it from the mains power supply.
2. Loosen the knurled screws, which secure the cover on the front of the system.
3. Pull the cover back and remove it.
4. Place the expansion card in or pull it out of the PCI bay on the backplane/motherboard and secure the cards or the covering plate to the rear of the device.
5. Close the device and secure the cover with the knurled screws.



Please read information provided by the manufacturer of any expansion cards before installing them or removing them from your system.

Installation in a 19" Industrial Cabinet



Expansion card installation should be performed before installing the KISS 2U-system into an industrial cabinet or into a control panel.

Refer to the **“Fehler! Verweisquelle konnte nicht gefunden werden.”** section

Before closing the industrial cabinet, you must connect your peripherals to the corresponding system ports. You will find a description of the ports, irrespective of the system configuration in the “External Ports of the SBC Cards (PCI-759/-760/-960)” or “External Ports of the 886LCD-M/Flex Motherboard” or “External Ports of the 986LCD-M/Flex Motherboard” chapters.



Important instructions!

The device must only be incorporated and installed by specialists who are qualified in this field.

The KISS 2U should be installed in a 19" industrial cabinet using slide rails.

Ensure that air flow around the device is adequate when installing the KISS 2U.

Ensure that the air inlet and outlet openings are kept clear and free from any obstructions.

Leave at least 5 cm (approx. 2") of free space to the front and rear of the KISS 2U when installing it from the 19" industrial cabinet, in order avoid possible overheating.



The 19" industrial cabinet must stand firmly in place. You can improve its stability by placing the components into it from the bottom up. Heavy components should be placed down below.

If further stabilization is necessary, then bolt the 19" industrial cabinet to the floor or anchor it on the wall.

The voltage feeds must not be overloaded. Adjust the cabling and the external overcharge protection to correspond with the electrical data indicated on the type label.

The type label is located on right side of the unit.

Starting Up

Connecting the Power Cable and Switching On

The AC mains input socket is located on the back of the KISS 2U.



The power source voltage must match the voltage on the type table.



AC power socket and power switch

Fig. 21: KISS 2U (here with an SBC card and a wide range AC power supply unit)



AC power socket and power switch

Fig. 21a: KISS 2U (here with a motherboard and a wide range AC power supply unit)

To connect the power cable, proceed as follows:

1. Plug the AC power cord into the system's AC power socket.
2. Plug the other end of the AC power cord into a corresponding power outlet.
3. Turn the device ON via the ON/OFF switch of the power supply unit located at the rear of the system.



Use a power cord suitable for the mains power supply in your country.

Make sure that the mains power supply (power outlet) is properly grounded and that the power cord is in perfect condition without any visible damage. An ungrounded mains power supply is not permissible.

Operating System and Hardware Component Drivers

Your computer can optionally be supplied with or without pre-installed operating system.

If you have ordered your KISS 2U with pre-installed operating system, all drivers are installed, corresponding to the ordered computer configuration (optional hardware components). Your computer is fully functional when you turn it on for the first time.

If you have ordered your KISS 2U without pre-installed operating system, you have to install the operating system and the corresponding drivers for the ordered computer configuration (optional hardware components).



The needed drivers can be downloaded from the web page www.kontron.com by selecting the product.



Consider the manufacturer specifications of the operating system and the integrated hardware components.

Maintenance and Prevention

Kontron Embedded Computers systems only require minimal maintenance and care to keep them operating correctly.

- Occasionally wipe the system with a soft dry cloth.
- Remove persistent dirt by use of a soft, slightly damp cloth (only use a mild detergent).
- Clean the air filter mat regularly.

Replacing System Fans



The operation of the KISS 2U platform is permitted only with a functional fan slide-in module.

Defective components may be replaced only by Kontron original spare parts.

□ part number of the fan slide-in module: 1009-1642

Important instructions!

The fan slide-in module is changeable while the system is powered-up. This maintenance may only be carried out by qualified personnel familiar with the associated dangers.

To replace the fan slide-in module, proceed as follows:

1. Open the device, as described in the “Installing Expansion Cards” chapter (Steps 2-3). Pull the cover back as far as necessary to gain access to the fan slide-in module.
2. Loosen the knurled screws (*Fig. 22, pos. 2*) and pull the handle on the fan slide-in module (*Fig. 22, 22b, pos. 5*) upwards out of the fan compartment (*Fig. 22a, pos. 7*).

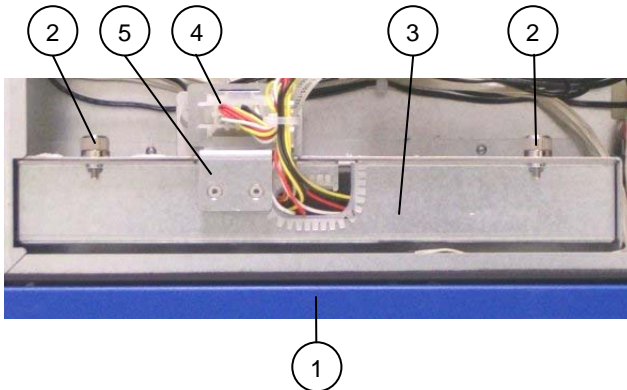

Fig. 22: KISS 2U – Details of the fan slide-in module in the system chassis

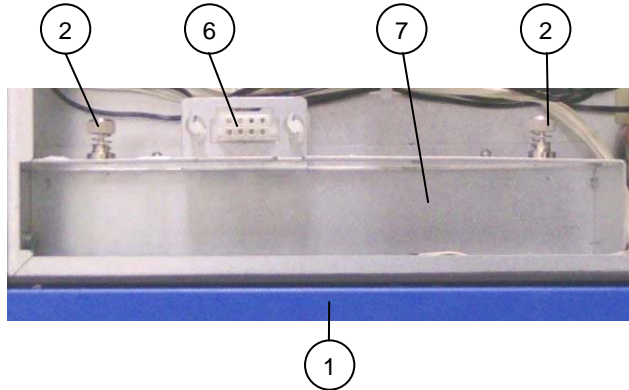

Fig. 22a: Fan compartment of the KISS 2U without a fan slide-in module

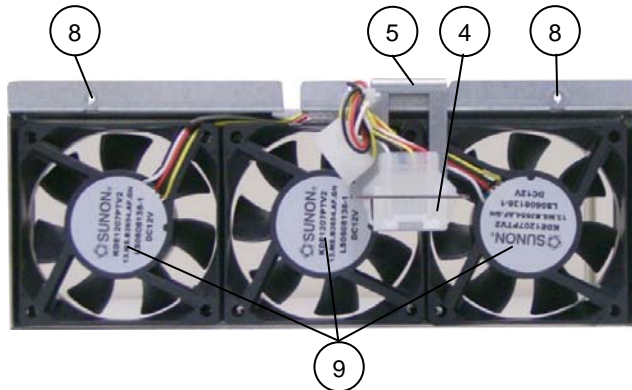

Fig. 22b: Fan slide-in module for the KISS 2U – connector side

Key for Figs. 22, 22a and 22b:

- | | | | |
|---|----------------------------|---|--|
| 1 | KISS front access panel | 6 | Socket for fan control |
| 2 | Knurled screws | 7 | Fan compartment (without a fan slide-in module) |
| 3 | Fan slide-in module | 8 | Threaded screw holes for the knurled screws on the fan slide-in module |
| 4 | Connector for fan control | 9 | 3x fans (temperature controlled) |
| 5 | Fan slide-in module handle | | |

3. Replace the fan slide-in module with a new functioning one and push it into the system fan compartment until it is attached to the connector.
4. Tighten the knurled screws up again.
5. Close the device and secure the cover with the knurled screws.

Cleaning the Filter Mat

Cleaning frequency depends on the operating environment. If the filter mat is too dirty, the SIMIS®-PC can overheat or at least warm up excessively. Therefore we recommend to clean the mat as often as possible depending on the degree of pollution. The filter mat which is accessible via the front access panel can be changed even if the system is powered up.

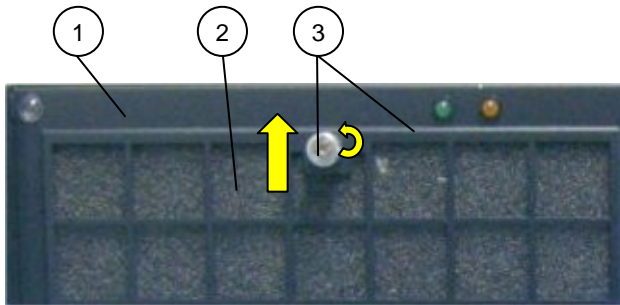

Fig. 23: Position of the filter mat

- | | | | |
|---|----------------------------|---|--------------------------------------|
| 1 | KISS 2U front access panel | 3 | Filter mat holder with knurled screw |
| 2 | Filter mat | | |

To replace the filter mat, proceed as follows:

1. Open the front access panel.
2. Loosen the screw that attaches the filter mat holder to the chassis.
3. Pull the filter mat holder in the direction of the arrow and lift it off.
4. Remove the dirty filter mat.
5. Clean the filter mat as follows:
 - Rinse in water (up to approx. 40°C/104°F; you may add a mild commercial detergent).
 - It is also possible to beat it, suction clean it or blast it with warm compressed air.
 - If the filter is soiled with greasy dust, you should rinse it with warm water with degreaser added. Do not clean the air filter mat with a piercing jet of water or wring it out.

6. After cleaning and drying the filter mat, place it in the filter mat holder. Re-attach the filter mat holder to the front of the chassis.
7. Screw the filter mat holder to the chassis using the fixing screw.



A defective air filter mat may be replaced only by a Kontron original spare part.

- ❑ Air filter mat: Part number: 1016-7164

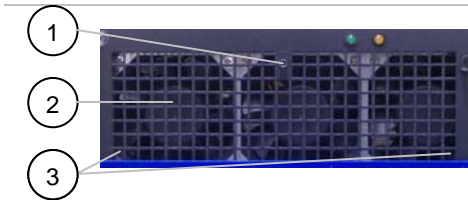

Fig. 24: Position of the filter mat holder

Key for Figs. 24, 24a and 24b:

- 1 Bolt with a threaded bore
- 2 Air inlet openings
- 3 Positional openings for the filter mat holder
- 4 Filter mat holder with knurled screw
- 5 Positional lug
- 6 Filter mat

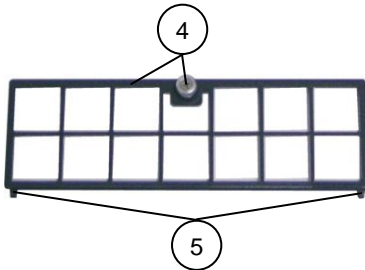

Fig. 24a: Filter mat holder without a mat



Fig. 24b: Filter mat

Replacing the Lithium Battery

The motherboard or SBC card for your system is equipped with a lithium battery. To replace the lithium battery, proceed as follows:

1. Open the device, as described in the “Installing Expansion Cards” chapter (steps 1-3).
2. If you have added expansion cards to your system, first remove the expansion cards plus all the corresponding connecting cables, to gain access to the lithium battery.
3. Remove the lithium battery from the holder by pulling the ejector spring outwards.
4. Place a new lithium battery in the battery holder.
5. When doing this, pay attention to the polarity of the battery (the plus should be at the top).
6. The lithium battery must only be replaced with the same type of battery or with a type of battery recommended by Kontron Embedded Computers.
7. Re-position the expansion cards and re-attach the connecting cables.
8. Close the device, as described in the “Installing Expansion Cards” chapter (step 5).



Do not dispose of lithium batteries in general trash collection. Dispose of the battery according to the local regulations dealing with the disposal of these special materials, (e.g. to the collecting points for dispose of batteries).

Slide Rails (Option)

Kontron stocks slide rails for installing the KISS 2U in an industrial cabinet. These slide rails can be ordered separately.

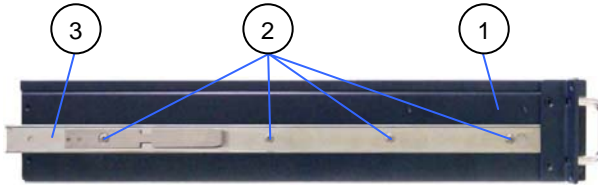

Fig. 25: Attaching the inner section of the slide rails



Fig. 25a: KISS 2U platform with slide rails

Key for figs.: 25 and 25a:

- | | |
|---|---|
| 1 Side view of KISS 2U | 3 Slide rail-Inner section |
| 2 3x M4x6 Round headed screws (for each side of the device) | 4 Slide rail [with brackets (short at the front, long at the back)] |



Please ensure that only the screws provided (M4x6) are used to attach the slide rails to the KISS 2U.

Slide Rails Accessories and Assembling

The “Slide Rails” set consists of the items listed below and is installed as shown in *Fig. 26*.

- ❑ One pair of slide rails
- ❑ One pair of short brackets for the front (with screws and washers)
- ❑ One pair of long brackets for the back (with screws and washers)
- ❑ 2x bar nut kits
- ❑ 8x M4x6 flathead screws

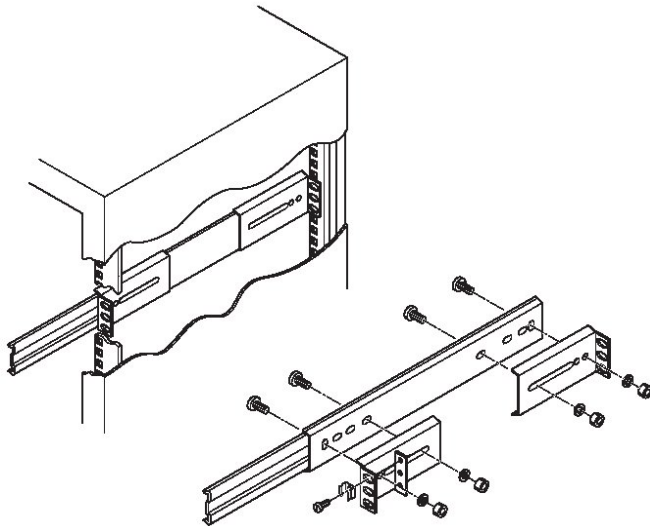

Fig. 26: Installing the “Telescopic Rail” sets



Short brackets are generally used at the front of the frame and long brackets at the back.

Installing the Device in an Industrial Cabinet (using Slide Rails)

1. Ensure that the sides of the KISS 2U chassis are parallel and square to the industrial cabinet.
2. Use the installation kits and brackets to attach the brackets to the telescopic rails (*Fig. 25a, pos. 4*). Loosely tighten the rear bracket.
3. Install the telescopic rails in the industrial cabinets.
4. Attach the inner section of the telescopic rails (*Fig. 25a, pos. 3*) to the KISS 2U chassis.
5. Place the KISS 2U in the industrial cabinet.
6. Check that the equipment moves evenly and smoothly.
7. Should it snag or should the rail movement be unsatisfactory:
 - Loosen the screws on the rear installation brackets and adjust the brackets.
 - Loosen the screws on the KISS 2U chassis.
 - Move the unit back and forward several times.
 - When the movement has improved, tighten the screws and move the unit the unit back and forward again.

Technical Data

KISS 2U	886-A/B	986-A/B	759-A/B	760-A/B	960-A/B
Installed Board					
886LCD-M/Flex	<input checked="" type="checkbox"/>				
986LCD-M/Flex		<input checked="" type="checkbox"/>			
PCI-759 (PICMG 1.0)			<input checked="" type="checkbox"/>		
PCI-760 (PICMG 1.3)				<input checked="" type="checkbox"/>	
PCI-960 (PICMG 1.3)					<input checked="" type="checkbox"/>
Interfaces (Rear)					
LAN10/100Mbps	3x				
LAN (10/100/1000Mbps)		2x	2x	2x	2x
USB 2.0	2x	4x	2x	2x	2x
IEEE-1394 (6-pol)		1x			
LPT	1x				
COM (RS232)	1x + 2x	1x + 2x			
VGA	1x	1x	1x	1x	1x
PS/2-Mouse	1x	1x			
PS/2- Keyboard	1x	1x			
Combined Keyboard&Mouse			1x		
Line-In	1x	1x			
Line-Out	1x	1x			
Microphone	1x	1x			
Audio (orange)		1x			
Audio (schw.)		1x			
Audio (grau)		1x			
On the Front Side					
USB 2.0	2x	2x	2x	2x	2x
Hard Disks & Drives					
1x 5,25" (extern)	1x	1x	1x	1x	1x
1x 3,5" (intern)	SATAI	SATAII	SATAII	SATAII	SATAII
Option: 1x 3,5" (intern)	SATAI	SATAII	SATAII	SATAII	SATAII
Option: 2x 2,5" (extern)	SATAI	SATAII	SATAII	SATAII	SATAII
Free Expansion Slots					
32 bit@33MHz	2x *FS	2x *FS	3x *FS 1x HS*	3x *FS	3x *FS
PCI_e x4				1x	1x
PCI_e x16				1x	1x

Lithium Battery	CR2032; 3.0 V; 0.22Ah
Controls	On / Off power supply switch (on the back; only on systems with a wide range AC power supply) Power On/Off button (on the front)
Indicators (on the front)	Power-LED (green) HDD-LED (orange)
Indicators (on the back)	2x Power LEDs (green) for a redundant power supply unit
AC Power Plug (on the back)	1x AC Wide Range 2x AC Wide Range Redundant

Used abbreviations in the „Technical Data“:

- *FS = Full Size (volle Länge)
- *HS = Half Size (halbe Länge)

Power Specification

Power specification (max. power values depending on customer- specific applications)	Power consumption per bay (PCI)	max. 25 W
	Total consumption of +3.3 VDC and +5 VDC and +12VDC (together)	280 W

Electrical Specifications

System Type	Product Designation	Integrated Power Supply Unit (PSU)	Input
KISS 2U	KISS 2U 886LCD-A	AC PSU Wide Range 300 W	V: 100-240 Hz: 50-60 A: max. 2.5
	KISS 2U 986LCD-A		
	KISS 2U 759-A		
	KISS 2U 760-A		
	KISS 2U 960-A		
	KISS 2U 886LCD-B	AC Redundant PSU Wide Range 300 W	V: 100-240 Hz: 50-60 A: max. 6
	KISS 2U 986LCD-B		
	KISS 2U 759-B		
	KISS 2U 760-B		
	KISS 2U 960-B		

Mechanical Specifications

Dimensions	KISS 2U (Standard Version)
Height	2U (87.8 mm) (3.5")
Width	Front: 19"; Chassis: 430 mm (16.929")
Depth	Chassis: 472.3 mm (16.929")
Weight (Excl. packaging)	Approx 10.00 kg (22.046 lbs.)
Housing	Chassis, black (RAL 7021) Front access panel, blue (RAL 5017)

Environmental Specifications

Ventilation	<p>1x power supply fan</p> <p>3x system fan (temperature controlled)</p> <p>1x CPU fan (for KISS 2U 759-/760-A/B)</p> <p>Passive CPU cooling for:</p> <p style="padding-left: 20px;">KISS 2U 960-A/B</p> <p style="padding-left: 20px;">KISS 2U 886LCD-A/B</p> <p style="padding-left: 20px;">KISS 2U 986LCD-A/B</p>
Operating Temperature / Humidity	<p>0 ... +50°C / 20-90 % not condensing (32 ... 122 °F / 20-90 %) not condensing</p> <p>For systems with redundant power supplies:</p> <p>0 ... +40°C / 20-90 % not condensing (32 ... 104 °F / 20-90 %) not condensing</p>
Storage / Transport Temperature / Relative Humidity	<p>-20 ... +70 °C / 10-90 % not condensing (-4 ... 158 °F / 10-90 %) not condensing</p>
Max. Operating Altitude	3,048 m (10,000 ft)
Max. Storage / Transport Altitude	10,000 m (32,810 ft)
Operating Shock	15 G, 11 ms duration, half sine
Storage / Transit Shock	30 G., 11 ms duration, half sine
Operating Vibration	10 – 500 Hz, 1.0 G
Storage / Transit Vibration	10 – 500 Hz, 2.0 G

EC Directives and Standards

CE Directives	
Electrical Safety	General Product Safety Directive (GPSD) 2001/95/EC Low Voltage Directive (LVD) 2006/95/EC
ElectroMagnetic Compatibility (EMC)	EMC Directive 2004/108/EC
CE Marking	Council Directive 93/68/EEC

Electrical Safety	Harmonized Standards
EUROPE	Information technology equipment - Safety - Part 1: General requirements EN 60950-1: 2006
U.S.A. / CANADA	Meet to UL60950-1:2006

EMC	Harmonized Standards
EUROPE	Generic emission standard for industrial environments (Emission): EN 61000-6-4:2006 Generic standards - Immunity for industrial environments (Immunity): EN 61000-6-2:2005
U.S.A.	FCC 47 CFR Part 15, Class A
CANADA	ICES-003, Class A

Standard Ports – Pin Assignment

Low-active signals are identified with a minus sign.

Serial port COM1 / 2 / 3 (RS232)

Pin	Signal Name	9-pin D-SUB Connector
1	DCD (Data Carrier Detect)	
2	RXD (Receive Data)	
3	TXD (Transmit Data)	
4	DTR (Data Terminal Ready)	
5	GND (Signal Ground)	
6	DSR (Data Set Ready)	
7	RTS (Request to Send)	
8	CTS (Clear to Send)	
9	RI (Ring Indicator)	

Combined PS/2 Keyboard and Mouse Connector

Pin	Signal Name	6-pin Mini-DIN Connector
1	Keyboard data	
2	Mouse data	
3	GND	
4	+5 V	
5	Keyboard clock	
6	Mouse clock	

PS/2 Mouse Connector

Pin	Signal Name	6-pin Mini-DIN Connector
1	Mouse data	
2	N.C.	
3	GND	
4	+5 V	
5	Mouse clock	
6	N.C.	

PS/2 Keyboard Connector

Pin	Signal Name	6-pin Mini-DIN Connector
1	Keyboard data	
2	N.C.	
3	GND	
4	+5 V	
5	Keyboard clock	
6	V.C.	

Parallel Port (LPT)

Pin	Signal Name	25-pin D-SUB Connector (female)
1	–STROBE	
2	DATA0	
3	DATA1	
4	DATA2	
5	DATA3	
6	DATA4	
7	DATA5	
8	DATA6	
9	DATA7	
10	–ACKN	
11	BUSY	
12	PE	
13	SELECT	
14	–AUTOFD	
15	–ERROR	
16	–INIT	
17	–SLCTIN	
18–25	GND	

VGA Port

Pin	Signal Name	15-pin D-SUB Connector (female)
1	Analog red output	
2	Analog green output	
3	Analog blue output	
4	N.C.	
5–8	GND	
9	+5 V (DDC)	
10	GND	
11	N.C.	
12	SDA (DDC)	
13	TTL HSync	
14	TTL VSync	
15	SCL (DDC)	

USB Port

Pin	Signal Name	4-pin USB Connector Type A Version 2.0
1	VCC	
2	Data-	
3	Data+	
4	GND	

Technical Support

For technical support, please contact our Technical Support team:

Tel: +49 (0)9461 950-104

Fax: +49 (0)9461 950-200

e-mail: support@kontron.com

Have the following details ready:

- the device's article number (P/No #),
- the device's serial number (S/No #) The serial number can be found on the name plate on the right hand side of the device.

Explain the nature of your problem to the service technician.

Should you require further information about Kontron Embedded Computers, our products or services, please contact us on the aforementioned telephone and fax numbers, or at: www.kontron.com or write to us at:

Kontron Embedded Computers GmbH

Oskar-von-Miller-Str. 1

85386 Eching

Germany

Returning Defective Merchandise

Before you return any device that is not functioning correctly to Kontron Embedded Computers, please work through the following list:

1. Contact our Customer Service department to obtain an RMA number.
Fax: (+49) 8165-77 412
e-mail: service@kontron.com
2. Ensure that you have received an RMA number from Kontron Customer Services before returning any device. Write this number clearly on the outside of the package that you are sending to us.
3. Describe the fault that has occurred.
4. Please provide the name and telephone number of a person we can contact to obtain more information, where necessary. Where possible, please enclose all the necessary customs documents and invoices.
5. When returning a device:
 - Pack it securely in its original box.
 - Enclose a copy of the RMA form with the consignment.