



FlatClient ECO and FlatClient PRO, FlatClient RCK and FlatClient STS

User Guide Rev. 2.3

Doc. ID: 1061-6259

This page has been intentionally left blank



FLATCLIENT ECO AND FLATCLIENT PRO, FLATCLIENT RCK AND FLATCLIENT STS – USER GUIDE

Disclaimer

Kontron would like to point out that the information contained in this user guide may be subject to alteration, particularly as a result of the constant upgrading of Kontron products. This document does not entail any guarantee on the part of Kontron with respect to technical processes described in the user guide or any product characteristics set out in the user guide. Kontron assumes no responsibility or liability for the use of the described product(s), conveys no license or title under any patent, copyright or mask work rights to these products and makes no representations or warranties that these products are free from patent, copyright or mask work right infringement unless otherwise specified. Applications that are described in this user guide are for illustration purposes only. Kontron makes no representation or warranty that such application will be suitable for the specified use without further testing or modification. Kontron expressly informs the user that this user guide only contains a general description of processes and instructions which may not be applicable in every individual case. In cases of doubt, please contact Kontron.

This user guide is protected by copyright. All rights are reserved by Kontron. No part of this document may be reproduced, transmitted, transcribed, stored in a retrieval system, or translated into any language or computer language, in any form or by any means (electronic, mechanical, photocopying, recording, or otherwise), without the express written permission of Kontron. Kontron points out that the information contained in this user guide is constantly being updated in line with the technical alterations and improvements made by Kontron to the products and thus this user guide only reflects the technical status of the products by Kontron at the time of publishing.

Brand and product names are trademarks or registered trademarks of their respective owners.

©2022 by Kontron Europe GmbH

Kontron Europe GmbH

Gutenbergstraße 2

85737 Ismaning

Germany

www.kontron.com

Intended Use

THIS DEVICE AND ASSOCIATED SOFTWARE ARE NOT DESIGNED, MANUFACTURED OR INTENDED FOR USE OR RESALE FOR THE OPERATION OF NUCLEAR FACILITIES, THE NAVIGATION, CONTROL OR COMMUNICATION SYSTEMS FOR AIRCRAFT OR OTHER TRANSPORTATION, AIR TRAFFIC CONTROL, LIFE SUPPORT OR LIFE SUSTAINING APPLICATIONS, WEAPONS SYSTEMS, OR ANY OTHER APPLICATION IN A HAZARDOUS ENVIRONMENT, OR REQUIRING FAIL-SAFE PERFORMANCE, OR IN WHICH THE FAILURE OF PRODUCTS COULD LEAD DIRECTLY TO DEATH, PERSONAL INJURY, OR SEVERE PHYSICAL OR ENVIRONMENTAL DAMAGE (COLLECTIVELY, "HIGH RISK APPLICATIONS").

You understand and agree that your use of Kontron devices as a component in High Risk Applications is entirely at your risk. To minimize the risks associated with your products and applications, you should provide adequate design and operating safeguards. You are solely responsible for compliance with all legal, regulatory, safety, and security related requirements concerning your products. You are responsible to ensure that your systems (and any Kontron hardware or software components incorporated in your systems) meet all applicable requirements. Unless otherwise stated in the product documentation, the Kontron device is not provided with error-tolerance capabilities and cannot therefore be deemed as being engineered, manufactured or setup to be compliant for implementation or for resale as device in High Risk Applications. All application and safety related information in this document (including application descriptions, suggested safety measures, suggested Kontron products, and other materials) is provided for reference only.

CAUTION

Handling and operation of the product is permitted only for trained personnel within a work place that is access controlled. Please follow the "General Safety Instructions" supplied with the system.

NOTICE

You find the most recent version of the "General Safety Instructions" online in the download area of this product.

NOTICE

This product is not suited for storage or operation in corrosive environments, in particular under exposure to sulfur and chlorine and their compounds. For information on how to harden electronics and mechanics against these stress conditions, contact Kontron Support.

Revision History

Revision	Brief Description of Changes	Date of Issue	Author
1.6	Initial Issue	2017-July-12	hjs
1.7	Added Skylake and Kaby Lake variants	2018-June-29	hjs
1.8	Changed the 15" built-in mechanical diagrams	2018-Oct-02	CW
1.9	Added 10.1", 12.2" and 13.3" chapter, added Apollo Lake variants, changed Power-in to 12-30VDC, Added French safety instructions	2019-Mar-21	hjs
1.92	Photo optimization in Table 2	2019-Jul-16	hjs
1.93	10.1" full metal variant integrated	2020-Feb-05	hjs
1.94	Torque moment added, TPM function added, slim variants added, changed UL 62368 in chapter 3/new type label	2020-Jul-13	hjs
1.95	7"-Version integrated, "General Safety Instructions " updated, Notice "cabinet doors thickness" in chapter 9.1 integrated	2020-Oct-13	hjs
1.96	UL content for General Safety Instructions added, Notice "Sunlit environment" inserted	2020-Nov-23	hjs
1.97	STS/RCK introduced, Order information modified, new certification reports in Table 1, Table 16 and Table 17, RFID Chapter 9.3 added	2021-Feb-23	hjs
1.98	Word2016 issues	2021-Mar-16	hjs
1.99	New Dimension Drawing 7"- and 21.5"-monitor, chipset J3455 and Whiskey Lake added, brightness in Table 6 corrected	2021-May-16	hjs
2.0	Updated Installation instructions	2021-Aug-09	CW
2.1	18,5" Panel Cutout added in chapter 7.22.1	2022-Jan-11	hjs
2.2	Exchange of figures in chapter 7.9, 7.13.1, 7.21, 7.27, 7.28, 7.31	2022-May-11	hjs
2.3	Extended Chapter 9.4 Startup Procedure, changed 15" brightness value, 13.3" dimensions in Table 5 and added panel cutout dimensions in Chapter 7.	2022-Aug-12	CW

Terms and Conditions

Kontron warrants products in accordance with defined regional warranty periods. For more information about warranty compliance and conformity, and the warranty period in your region, visit <http://www.kontron.com/terms-and-conditions>.

Kontron sells products worldwide and declares regional General Terms & Conditions of Sale, and Purchase Order Terms & Conditions. Visit <http://www.kontron.com/terms-and-conditions>.

For contact information, refer to the corporate offices contact information on the last page of this user guide or visit our website [CONTACT US](#).

Customer Support

Find Kontron contacts by visiting <https://www.kontron.com/support-and-services>.

Customer Service

As a trusted technology innovator and global solutions provider, Kontron extends its embedded market strengths into a services portfolio allowing companies to break the barriers of traditional product lifecycles. Proven product expertise coupled with collaborative and highly-experienced support enables Kontron to provide exceptional peace of mind to build and maintain successful products.

For more details on Kontron's service offerings such as: enhanced repair services, extended warranty, Kontron training academy, and more visit <https://www.kontron.com/support-and-services>.

Customer Comments

If you have any difficulties using this user guide, discover an error, or just want to provide some feedback, contact [Kontron support](#). Detail any errors you find. We will correct the errors or problems as soon as possible and post the revised user guide on our website.

Symbols

The following symbols may be used in this user guide

DANGER

DANGER indicates a hazardous situation which, if not avoided, will result in death or serious injury.

WARNING

WARNING indicates a hazardous situation which, if not avoided, could result in death or serious injury.

NOTICE

NOTICE indicates a property damage message.

CAUTION

CAUTION indicates a hazardous situation which, if not avoided, may result in minor or moderate injury.



Electric Shock!

This symbol and title warn of hazards due to electrical shocks (> 60 V) when touching products or parts of products. Failure to observe the precautions indicated and/or prescribed by the law may endanger your life/health and/or result in damage to your material.



ESD Sensitive Device!

This symbol and title inform that the electronic boards and their components are sensitive to static electricity. Care must therefore be taken during all handling operations and inspections of this product in order to ensure product integrity at all times.



HOT Surface!

Do NOT touch! Allow to cool before servicing.



Laser!

This symbol inform of the risk of exposure to laser beam and light emitting devices (LEDs) from an electrical device. Eye protection per manufacturer notice shall review before servicing.



This symbol indicates general information about the product and the user guide.

This symbol also indicates detail information about the specific product configuration.



This symbol precedes helpful hints and tips for daily use.

For Your Safety

Your new Kontron product was developed and tested carefully to provide all features necessary to ensure its compliance with electrical safety requirements. It was also designed for a long fault-free life. However, the life expectancy of your product can be drastically reduced by improper treatment during unpacking and installation. Therefore, in the interest of your own safety and of the correct operation of your new Kontron product, you are requested to conform with the following guidelines.

High Voltage Safety Instructions

As a precaution and in case of danger, the power connector must be easily accessible. The power connector is the product's main disconnect device.

⚠ CAUTION

Warning

All operations on this product must be carried out by sufficiently skilled personnel only.

⚠ CAUTION



Electric Shock!

Before installing a non hot-swappable Kontron product into a system always ensure that your mains power is switched off. This also applies to the installation of piggybacks. Serious electrical shock hazards can exist during all installation, repair, and maintenance operations on this product. Therefore, always unplug the power cable and any other cables which provide external voltages before performing any work on this product.

Earth ground connection to vehicle's chassis or a central grounding point shall remain connected. The earth ground cable shall be the last cable to be disconnected or the first cable to be connected when performing installation or removal procedures on this product.

Special Handling and Unpacking Instruction

NOTICE



ESD Sensitive Device!

Electronic boards and their components are sensitive to static electricity. Therefore, care must be taken during all handling operations and inspections of this product, in order to ensure product integrity at all times.

⚠ CAUTION

Handling and operation of the product is permitted only for trained personnel within a work place that is access controlled. Follow the "General Safety Instructions" supplied with the product.

Do not handle this product out of its protective enclosure while it is not used for operational purposes unless it is otherwise protected.

Whenever possible, unpack or pack this product only at EOS/ESD safe work stations. Where a safe work station is not guaranteed, it is important for the user to be electrically discharged before touching the product with his/her hands or tools. This is most easily done by touching a metal part of your system housing.

It is particularly important to observe standard anti-static precautions when changing piggybacks, ROM devices, jumper settings etc. If the product contains batteries for RTC or memory backup, ensure that the product is not placed on conductive surfaces, including anti-static plastics or sponges. They can cause short circuits and damage the batteries or conductive circuits on the product.

Lithium Battery Precautions

If your product is equipped with a lithium battery, take the following precautions when replacing the battery.

⚠ CAUTION

Risk of Explosion if Battery is replaced by an incorrect Type. Dispose of used batteries According to the instructions.

Risque d'explosion si la batterie est remplacée par un type incorrect. Mettre au rebus les batteries usagées selon les instructions.

General Instructions on Usage

In order to maintain Kontron's product warranty, this product must not be altered or modified in any way. Changes or modifications to the product, that are not explicitly approved by Kontron and described in this user guide or received from Kontron Support as a special handling instruction, will void your warranty.

This product should only be installed in or connected to systems that fulfill all necessary technical and specific environmental requirements. This also applies to the operational temperature range of the specific board version that must not be exceeded. If batteries are present, their temperature restrictions must be taken into account.

In performing all necessary installation and application operations, only follow the instructions supplied by the present user guide.

Keep all the original packaging material for future storage or warranty shipments. If it is necessary to store or ship the product then re-pack it in the same manner as it was delivered.

Special care is necessary when handling or unpacking the product. See Special Handling and Unpacking Instruction.

Quality and Environmental Management

Kontron aims to deliver reliable high-end products designed and built for quality, and aims to complying with environmental laws, regulations, and other environmentally oriented requirements. For more information regarding Kontron's quality and environmental responsibilities, visit <http://www.kontron.com/about-kontron/corporate-responsibility/quality-management>.

Disposal and Recycling

Kontron's products are manufactured to satisfy environmental protection requirements where possible. Many of the components used are capable of being recycled. Final disposal of this product after its service life must be accomplished in accordance with applicable country, state, or local laws or regulations.

WEEE Compliance

The Waste Electrical and Electronic Equipment (WEEE) Directive aims to:

- ▶ Reduce waste arising from electrical and electronic equipment (EEE)
- ▶ Make producers of EEE responsible for the environmental impact of their products, especially when the product become waste
- ▶ Encourage separate collection and subsequent treatment, reuse, recovery, recycling and sound environmental disposal of EEE
- ▶ Improve the environmental performance of all those involved during the lifecycle of EEE



Environmental protection is a high priority with Kontron.

Kontron follows the WEEE directive

You are encouraged to return our products for proper disposal.

Table of Contents

Symbols	7
For Your Safety	8
High Voltage Safety Instructions	8
Special Handling and Unpacking Instruction	8
Lithium Battery Precautions	9
General Instructions on Usage	9
Quality and Environmental Management	9
Disposal and Recycling	9
WEEE Compliance	9
Table of Contents	10
List of Tables	12
List of Figures	13
1/ Introduction	15
2/ General Safety Instructions	16
2.1. UL Canada: Instructions générales de sécurité	17
2.2. Electromagnetic Compatibility EU	18
2.3. Electrostatic Discharge (ESD)	19
2.3.1. Grounding Methods	19
3/ Scope of Delivery	20
3.1.1. Type Label and Product Identification	22
4/ Product Features	23
4.1. Front Features	23
4.2. Rear Panel Features	24
5/ Order Information	25
6/ Product Specification	28
6.1. Technical Specification	28
6.2. Environmental Specification	34
6.3. Power Specification	34
6.4. Compliance	35
7/ Mechanical Specification	36
7.1. 7.0" Built-in Variant	36
7.2. 7.0" Panel Cutout Dimensions	36
7.3. 10.1" Built-in Variant	37
7.3.1. 10.1" Panel Cutout	37
7.4. 10.1" Full-metal Variant	37
7.5. 10.4" Built-in Variant	38
7.5.1. 10.4" Panel Cutout	38
7.6. 10.4" Full-metal Variant	38
7.7. 12.1" Built-in Variant WXGA (1280x800)	39
7.7.1. 12.1" WXGA Panel Cutout	39
7.8. 12.1" Full-metal Variant WXGA (1280x800)	39
7.9. 12.1" Built-in Variant SVGA and XGA (800x600, 1024x768)	40
7.9.1. 12.1" Panel Cutout	40
7.10. 12.1" Full-metal Variant SVGA and XGA (800x600, 1024x768)	40
7.11. 13.3" Built-in Variant	41
7.11.1. 13.3" Panel Cutout	41
7.12. 13.3" Full-metal Variant	41

7.13. 15.0" Built-in Variant	42
7.13.1. 15.0" Panel Cutout	42
7.14. 15.0" Full-metal VESA Variant.....	42
7.15. 15.6" Built-in Variant.....	43
7.15.1. 15.6" Panel Cutout.....	43
7.16. 15.6" Built-in Slim Variant.....	44
7.16.1. 15.6" Built-in (slim) Panel Cutout	44
7.17. 15.6" Full-metal Variant.....	45
7.18. 15.6" VESA Slim Variant	45
7.19. 17.0" Built-in Variant	46
7.19.1. 17.0" Panel Cutout.....	46
7.20. 17.0" Full-metal Variant	47
7.21. 18.5" Built-in Variant (HD and FullHD).....	48
7.21.1. 18.5" Panel Cutout	48
7.22. 18.5" Built-in Slim Variant (HD and FullHD)	49
7.22.1. 18.5" Panel Cutout.....	49
7.23. 18.5" Full-metal VESA Variant (HD and FullHD)	50
7.24. 18.5" VESA Slim Variant (HD and FullHD)	50
7.25. 19.0" Built-in Variant.....	51
7.25.1. 19.0" Panel Cutout.....	51
7.26. 19.0" Full-metal VESA Variant	52
7.27. 19" Monitor Rackmount (RCK)21.5" Built-in Variant.....	52
7.27.1. 21.5" Panel Cutout.....	53
7.28. 21.5" Built-in Slim Variant (HD and FullHD)	54
7.28.1. 21.5" Slim Variant Panel Cutout.....	54
7.29. 21.5" Full-metal Variant.....	55
7.30. 21.5" VESA Slim Variant	55
7.31. 23.8" Built-in Variant	56
7.31.1. 23.8 "Panel Cutout.....	56
7.32. 23.8" Full-metal Variant.....	56
8/ Connectors.....	57
8.1. FlatClient ECO Intel BayTrail J1900.....	57
8.2. FlatClient ECO Intel BayTrail J1900 7" Variant.....	57
8.2.1. Input Power Connector.....	58
8.2.2. Power-Switch and LEDs.....	58
8.2.3. USB2.0 Type-A Connector.....	59
8.2.4. USB3.0 Type-A Connector	59
8.2.5. GbE RJ-45 Connector	59
8.2.6. LED Diagram of LAN Connectors	59
8.2.7. HDMI Connector.....	60
8.2.8. DB15 VGA Connector	60
8.2.9. COM2 RS-232/422/485 (via internal cable connection to CN16, Option)	61
8.3. FlatClient ECO Apollo Lake N4200/Intel® Celeron® J3455.....	62
8.3.1. Input Power Connector.....	62
8.3.2. Power-Switch and LEDs.....	63
8.3.3. USB2.0 Type-A Connector.....	63
8.3.4. USB3.0 Type-A Connector	64
8.3.5. GbE RJ-45 Connector	64
8.3.6. LED Diagram of LAN Connectors	64

8.3.7. HDMI Connector.....	65
8.3.8. DB15 VGA Connector	65
8.3.9. COM2 RS-232/422/485 (via internal cable connection to CN16, Option)	66
8.4. FlatClient PRO Haswell.....	67
8.4.1. Input Power Connector.....	67
8.4.2. Power-Switch and LEDs.....	68
8.4.3. USB3.0 Type-A Connector	68
8.4.4. GbE RJ-45 Connector.....	69
8.4.5. LED Diagram of LAN Connectors	69
8.4.6. DisplayPort Connector.....	69
8.4.7. COM2 RS-232/422/485 (via internal cable connection to CN16, Option)	70
8.5. FlatClient PRO Skylake/Kaby Lake/Whiskey Lake	71
8.5.1. Input Power Connector	71
8.5.2. Power-Switch and LEDs	72
8.5.3. USB3.0 Type-A Connector.....	72
8.5.4. GbE RJ-45 Connector	73
8.5.5. LED Diagram of LAN Connectors.....	73
8.5.6. DisplayPort Connector	73
8.5.7. HDMI Connector.....	74
9/ Installation and Start	75
9.1. Mounting Instructions Built-in-variant	75
9.2. Mounting Instructions VESA.....	77
9.3. Mounting Instructions Rack.....	77
9.4. Startup Procedure.....	78
9.4.1. Connecting to a Power Supply	78
9.4.2. Wiring the Mating Power Connector.....	79
9.4.3. Switch On and Off.....	80
9.5. RFID (Optional).....	80
10/ Technical Support	81
10.1. Returning Defective Merchandise	81
11/ Storage, Transportation and Maintenance.....	82
11.1. Storage.....	82
11.2. Transportation	82
11.3. Maintenance.....	82
11.4. Cleaning the Display.....	82
12/ Warranty	83
Appendix: List of Acronyms	84
About Kontron – Member of the S&T Group	85

List of Tables

Table 1: Electromagnetic Compatibility CE.....	18
Table 2: Scope of Delivery	20
Table 3: List of Accessories.....	20
Table 4: Technical Data FlatClient ECO and FlatClient PRO Line	28
Table 5: Technical Data FlatClient ECO and FlatClient PRO Line.....	28
Table 6: Technical Data FlatClient ECO and FlatClient PRO Line	29
Table 7: Technical Data FlatClient ECO and FlatClient PRO Line.....	29
Table 8: Technical Data for FlatClient ECO Line with BayTrail and Braswell processors.....	30
Table 9: Current Rating at 12 V for FlatClient ECO Line with Intel® Celeron Quad Core J1900	30

Table 10: Technical Data FlatClient ECO Line with Intel® Pentium® CPU N4200/Intel® Celeron® J3455.....	31
Table 11: Current Rating at 12 V for FlatClient ECO Line with Intel® Pentium® CPU N4200/Intel® Celeron® J3455.....	31
Table 12: Technical Data FlatClient PRO Line with Haswell and Broadwell processors	32
Table 13: Current Rating at 12 V for FlatClient PRO Line with Intel® Haswell ULT i5-4300U	32
Table 14: Technical Data FlatClient PRO Line with Skylake, Whiskey Lake and Kaby Lake CPU	33
Table 15: Current Rating at 12 V for FlatClient PRO Line with Intel® Core™ i5-6300U/Core™ i5-7300U/Core™ i5-8365UE.....	33
Table 16: Environmental Specification FlatClient ECO and FlatClient PRO Line	34
Table 17: Directives and Standards Compliance.....	35
Table 18: Button Functions (1).....	58
Table 19: Power LED (2).....	58
Table 20: Drive Activity (3)	59
Table 21: Pinout USB 2.0.....	59
Table 22: Pinout USB 2.0	59
Table 23: Pinout GbE RJ-45 Connector	59
Table 24: Pinout HDMI Connector	60
Table 25: Pinout VGA Connector	60
Table 26: Pinout RS-232/422/485 Connector	61
Table 27: Power LED (1).....	63
Table 28: Button Functions (2)	63
Table 29: Drive Activity (3)	63
Table 30: Pinout USB 2.0	63
Table 31: Pinout USB 2.0.....	64
Table 32: Pinout GbE RJ-45 Connector	64
Table 33 : Status of LEDs from GbE RJ-45 Connector	64
Table 34: Pinout HDMI Connector	65
Table 35: Pinout VGA Connector	65
Table 36: Pinout RS-232/422/485 Connector	66
Table 37: Power On Button Functions (1).....	68
Table 38: Power LED (2).....	68
Table 39: Drive Activity (3)	68
Table 40: Pinout USB3.0 Connector	68
Table 41: Pinout GbE RJ-45 Connector	69
Table 42: Pinout DisplayPort Connector.....	69
Table 43: Pinout RS-232/422/485 Connector	70
Table 44: Power LED (1).....	72
Table 45: Button Functions (2)	72
Table 46: Drive Activity (3).....	72
Table 47: Pinout USB 2.0	72
Table 48: Pinout GbE RJ-45 Connector.....	73
Table 49: Pinout DisplayPort Connector.....	73
Table 50: Pinout HDMI Connector	74

List of Figures

Figure 1: FlatClient ECO and PRO, FlatClient STS and FlatClient RCK (right).....	15
Figure 2: Type Label.....	22
Figure 3: Front View Description FlatClient ECO Full-metal	23
Figure 4: Rear Panel Description – FlatClient ECO (BayTrail) Full-metal variant.....	24
Figure 5: Rear Panel Description – FlatClient PRO (Braswell) built-in variant.....	24
Figure 6: Interfaces for Panel PC FlatClient ECO.....	57
Figure 7: Interfaces for Panel PC FlatClient ECO 7" variant.....	57
Figure 8: Input Power Connector.....	58
Figure 9: Mating Power Connector	58
Figure 10: Power-Switch and LEDs.....	58
Figure 11: Interfaces for Panel PC FlatClient Apollo Lake variant.....	62

Figure 12: Input Power Connector 62

Figure 13: Mating Power Connector 62

Figure 14: Power-Switch and LEDs..... 63

Figure 15: Interfaces for Panel PC PRO variant 67

Figure 16: Input Power Connector 67

Figure 17: Mating Power Connector..... 67

Figure 18: Power-Switch and LEDs..... 68

Figure 19: Interfaces for Panel PC FlatClient PRO Skylake/Kaby Lake variant..... 71

Figure 20: Input Power Connector 71

Figure 21: Mating Power Connector 71

Figure 22: Power-Switch and LEDs 72

Figure 23: Mating Power Connector 79

Figure 24: Screen with optional RFID function (red circle)..... 80

1/ Introduction

With its FlatClient Monitor series, Kontron offers high mechanical flexibility with respect to the design. It can be used both as a full-metal solution with VESA 75/75 respectively 100/100 as well as a built-in solution. The front comes with standard IP65 protection, with the full-metal variant offering a standard IP54. The built-in version is installed directly on the machine or in a command or control console.

The system is service-friendly for the user and is designed for a long life cycle thanks to carefully selected components from renowned manufacturers.

The FlatClient industrial monitor series includes the FlatClient STS stainless steel monitor built-in variant that installs directly on the machine or in a command or control console. For industrial applications, the FlatClient RCK rack mount provides easy 19" industrial rack installation.

Figure 1: FlatClient ECO and PRO, FlatClient STS and FlatClient RCK (right)



2/ General Safety Instructions

Please read this passage carefully and take careful note of the instructions, which have been compiled for your safety and to ensure to apply in accordance with intended regulations. If the following general safety instructions are not observed, it could lead to injuries to the operator and/or damage of the product; in cases of non-observance of the instructions Kontron Europe is exempt from accident liability, this also applies during the warranty period.

The product has been built and tested according to the basic safety requirements for low voltage (LVD) applications and has left the manufacturer in safety-related, flawless condition. To maintain this condition and to also ensure safe operation, the operator must not only observe the correct operating conditions for the product but also the following general safety instructions:

- ▶ The product must be used as specified in the product documentation, in which the instructions for safety for the product and for the operator are described. These contain guidelines for setting up, installation and assembly, maintenance, transport or storage.
- ▶ The on-site electrical installation must meet the requirements of the country's specific local regulations.
- ▶ If a power cable comes with the product, only this cable should be used. Do not use an extension cable to connect the product.
- ▶ To guarantee that sufficient air circulation is available to cool the product, please ensure that the ventilation openings are not covered or blocked. If a filter mat is provided, this should be cleaned regularly. Do not place the product close to heat sources or damp places. Make sure the product is well ventilated.
- ▶ Only connect the product to an external power supply providing the voltage type (AC or DC) and the input power (max. current) specified on the Kontron Product Label and meeting the requirements of the Limited Power Source (LPS) and Power Source (PS2) of UL/IEC 62368-1.
- ▶ Only products or parts that meet the requirements for Power Source (PS1) of UL/IEC 62368-1 may be connected to the product's available interfaces (I/O).
- ▶ Before opening the product, make sure that the product is disconnected from the mains.
- ▶ Switching off the product by its power button does not disconnect it from the mains. Complete disconnection is only possible if the power cable is removed from the wall plug or from the product. Ensure that there is free and easy access to enable disconnection.
- ▶ The product may only be opened for the insertion or removal of add-on cards (depending on the configuration of the product). This may only be carried out by qualified operators.
- ▶ If extensions are being carried out, the following must be observed:
 - ▶ all effective legal regulations and all technical data are adhered to
 - ▶ the power consumption of any add-on card does not exceed the specified limitations
 - ▶ the current consumption of the product does not exceed the value stated on the product label
- ▶ Only original accessories that have been approved by Kontron Europe can be used.
- ▶ Please note: safe operation is no longer possible when any of the following applies:
 - ▶ the product has visible damages or
 - ▶ the product is no longer functioning
 In this case the product must be switched off and it must be ensured that the product can no longer be operated.
- ▶ Handling and operation of the product is permitted only for trained personnel within a work place that is access controlled.
- ▶ CAUTION: Risk of explosion if the battery is replaced incorrectly (short-circuited, reverse-poled, wrong battery type). Dispose of used batteries according to the manufacturer's instructions.
- ▶ This product is not suitable for use in locations where children are likely to be present

Additional Safety Instructions for DC Power Supply Circuits

- ▶ To guarantee safe operation, please observe that:
 - ▶ the external DC power supply must meet the criteria for LPS and PS2 (UL/IEC 62368-1)
 - ▶ no cables or parts without insulation in electrical circuits with dangerous voltage or power should be touched directly or indirectly
 - ▶ a reliable protective earthing connection is provided

- ▶ a suitable, easily accessible disconnecting device is used in the application (e.g. overcurrent protective device), if the product itself is not disconnect able
- ▶ a disconnect device, if provided in or as part of the product, shall disconnect both poles simultaneously
- ▶ interconnecting power circuits of different products cause no electrical hazards
- ▶ A sufficient dimensioning of the power cable wires must be selected – according to the maximum electrical specifications on the product label – as stipulated by EN62368-1 or VDE0100 or EN60204 or UL61010-1 regulations.

For the General Safety Instruction in German or French, visit [Kontron's product web page> Downloads> Manuals> General Safety Instructions.](#)

2.1. UL Canada: Instructions générales de sécurité

Veillez lire attentivement ce passage et prendre bonne note des instructions, qui ont été compilées pour votre sécurité et pour assurer une application conforme aux réglementations prévues. Le non-respect des consignes de sécurité générales suivantes peut entraîner des blessures pour l'utilisateur et/ou des dommages pour le produit. En cas de non-respect des consignes, Kontron Europe est exonéré de la responsabilité en cas d'accident, ceci s'applique également pendant la période de garantie.

Le produit a été construit et testé conformément aux exigences de sécurité de base pour les applications basse tension (DBT) et a quitté le fabricant dans un état impeccable en matière de sécurité. Pour maintenir cet état et pour garantir également un fonctionnement sûr, l'opérateur doit non seulement respecter les conditions d'utilisation correctes du produit, mais aussi les consignes de sécurité générales suivantes :

- ▶ Le produit doit être utilisé conformément à la documentation du produit, dans laquelle sont décrites les instructions de sécurité pour le produit et pour l'opérateur. Celles-ci contiennent des directives pour la mise en place, l'installation et le montage, la maintenance, le transport ou le stockage.
- ▶ L'installation électrique sur place doit répondre aux exigences des réglementations locales spécifiques du pays.
- ▶ Si un câble d'alimentation est fourni avec le produit, seul ce câble doit être utilisé. N'utilisez pas de rallonge pour connecter le produit.
- ▶ Afin de garantir une circulation d'air suffisante pour refroidir le produit, veillez vous assurer que les ouvertures de ventilation ne sont pas couvertes ou obstruées. Si un élément filtrant est fourni, celui-ci doit être nettoyé régulièrement. Ne placez pas le produit à proximité de sources de chaleur ou d'endroits humides. Veillez à ce que le produit soit bien ventilé.
- ▶ Ne connectez le produit qu'à une alimentation externe fournissant le type de tension (AC ou DC) et la puissance d'entrée (courant max.) spécifiés sur le Label Produit Kontron et répondant aux exigences de la source d'alimentation limitée (LPS) et de la source d'alimentation (PS2) de la norme UL/IEC 62368-1.
- ▶ Seuls les produits ou les pièces qui répondent aux exigences de la source d'alimentation (PS1) de la norme UL/IEC 62368-1 peuvent être connectés aux interfaces (E/S) disponibles du produit.
- ▶ Avant d'ouvrir le produit, assurez-vous qu'il est bien débranché du secteur.
- ▶ Le fait d'éteindre le produit par son bouton de mise en marche ne le déconnecte pas du secteur. Une déconnexion complète n'est possible que si le câble d'alimentation est retiré de la prise murale ou du produit. Veillez à ce que l'accès soit libre et facile pour permettre la déconnexion.
- ▶ Le produit ne peut être ouvert que pour l'insertion ou le retrait de cartes supplémentaires (selon la configuration du produit). Cette opération ne peut être effectuée que par des opérateurs qualifiés.
- ▶ Si des extensions sont effectuées, les points suivants doivent être respectés :
 - ▶ toutes les réglementations légales en vigueur et toutes les données techniques sont respectées
 - ▶ la consommation électrique d'une carte supplémentaire ne dépasse pas les limites spécifiées
 - ▶ la consommation actuelle du produit ne dépasse pas la valeur indiquée sur l'étiquette du produit.
- ▶ Seuls les accessoires d'origine approuvés par Kontron Europe peuvent être utilisés.
- ▶ Veillez noter que la sécurité des opérations n'est plus possible lorsque l'une des conditions suivantes s'applique.
 - ▶ le produit présente des dommages visibles ou

- ▶ le produit ne fonctionne plus. Dans ce cas, le produit doit être éteint et il faut s'assurer que le produit ne puisse plus être utilisé.
 - ▶ La manipulation et le fonctionnement du produit ne sont autorisés que pour le personnel formé dans un lieu de travail dont l'accès est contrôlé.
 - ▶ ATTENTION: Risque d'explosion si la batterie est remplacée de manière incorrecte (court-circuit, inversion de polarité, mauvais type de batterie). Éliminez les piles usagées conformément aux instructions du fabricant.
 - ▶ Ce produit n'est pas adapté à une utilisation dans des endroits où des enfants sont susceptibles d'être présents
- Instructions de sécurité supplémentaires pour les circuits d'alimentation en courant continu
- ▶ Pour garantir un fonctionnement sûr, veuillez observer ce qui suit:
 - ▶ l'alimentation électrique externe en courant continu doit répondre aux critères des LPS et PS2 (UL/IEC 62368-1)
 - ▶ aucun câble ou pièce non isolée dans les circuits électriques ayant une tension ou une puissance dangereuse ne doit être touché directement ou indirectement
 - ▶ une connexion fiable à la terre de protection est fournie
 - ▶ un dispositif de déconnexion approprié et facilement accessible est utilisé dans l'application (par exemple, un dispositif de protection contre les surintensités), si le produit lui-même n'est pas en mesure d'être déconnecté.
 - ▶ un dispositif de déconnexion, s'il est prévu dans le produit ou s'il en fait partie, doit déconnecter les deux pôles simultanément
 - ▶ l'interconnexion des circuits électriques de différents produits ne présente aucun risque électrique
 - ▶ Un dimensionnement suffisant des fils du câble d'alimentation doit être choisi - en fonction des spécifications électriques maximales figurant sur l'étiquette du produit - comme stipulé par les réglementations EN62368-1 ou VDE0100 ou EN60204 ou UL61010-1.

2.2. Electromagnetic Compatibility EU

This product is in conformity with the protection requirements of EU Council Directive 2004/108/EC on the approximation of the laws of the Member States relating to electromagnetic compatibility. If the user modifies and/or adds to the equipment (e.g. installation of add-on cards) the prerequisites for the CE conformity declaration, (safety requirements) may no longer apply.

Table 1: Electromagnetic Compatibility CE

EN 55032:2015	Information technology equipment, Radio disturbance characteristics, Limits and methods of measurement (CISPR 32:2015)
EN 61000-6-2:2005 + Cor.:2005	Electromagnetic compatibility (EMC), Part 6-2:Generic Standards - Immunity for industrial environments+ CENELEC- Cor.:2005

2.3. Electrostatic Discharge (ESD)

A sudden discharge of electrostatic electricity can destroy static-sensitive devices or micro-circuitry. Therefore, proper packaging and grounding techniques are necessary precautions to prevent damage.

Always take the following precautions:



ESD Sensitive Device!

Keep electrostatic sensitive parts in their containers until they arrive at the ESD-safe workplace. Always be properly grounded when touching a sensitive board, component, or assembly.

For more Information, see the Special Handling and Unpacking Instruction within this user guide and Chapter 2.3.1: Grounding Methods below.

2.3.1. Grounding Methods

The following measures help to avoid electrostatic damages to the device:

- ▶ Cover workstations with approved antistatic material. Always wear a wrist strap connected to the workplace, as well as properly grounded tools and equipment.
- ▶ Use antistatic mats, heel straps, or air ionizers for more protection.
- ▶ Always handle electrostatically sensitive components by their edge or by their casing.
- ▶ Avoid contact with pins, leads, or circuitry.
- ▶ Turn off power and input signals before inserting and removing connectors or connecting test equipment.
- ▶ Keep the work area free of non-conductive materials such as ordinary plastic assembly aids and styrofoam.
- ▶ Use field service tools such as cutters, screwdrivers, and vacuum cleaners that are conductive.
- ▶ Always place drives and boards with the PCB-assembly-side down on the foam.

2.4. Instructions for Lithium Battery

If the product is equipped with a lithium battery. When replacing the battery observe the instructions below.

CAUTION

Risk of Explosion if Battery is replaced by an incorrect Type. Dispose of used batteries According to the instructions.

Risque d'explosion si la batterie est remplacée par un type incorrect. Mettre au rebus les batteries usagées selon les instructions.



Do not dispose of lithium batteries in general trash collection. Dispose of the battery according to the local regulations dealing with the disposal of these special materials, (e.g. to the collecting points for dispose of batteries).

3/ Scope of Delivery

This chapter describes the components that are delivered and can be optionally ordered.

Please check that your delivery is complete and contains the items below (according to the ordered unit configuration). If you discover damaged or missing items, please contact your dealer.

Table 2: Scope of Delivery









	Qty	Part Number	Part Description
	1	s. order information chapter 5/	FlatClient ECO or PRO Monitor
	1	EM21-100189-01 (7.0") EM21-100168-01 (10.1") EM21-100065-0 (10.4"/12.1") 1064-9094 (13.3") EM21-100066-0 (15.0"/15.6") EM21-100067-01 (17.0"/19.0") EM21-100068-01 (18.5"/23.8") EM21-100069-01 (21.5")	Mounting set with clamps and screws, only for built-in variant
	1	EE04-100001-01	Phoenix 3 pin Power Subcon in D-sub 9 connector.
	1	840-0059	EU-Power cord 1,8m
	1	ER40-100001-01	Power Supply Set 24 VDC /w Phoenix Connector
	1	ER40-100005-01	Power supply Set 24 VDC /w Phoenix incl. EU-Power cord 1,8m

Table 3: List of Accessories

	Qty	Part Number	Part Description
	1	PR22-100004-01	Adapter Kabel HDMI - DisplayPort, 20cm, 4K aktiv, Delock: 62607
	1	PR22-100005-01	Adapter HDMI - DisplayPort 1.2, 4K aktiv, Delock: 65573
	1	PR22-100006-01	Adapter DVI-D - DisplayPort 1.1, Delock: 65257

	Qty	Part Number	Part Description
	1	PR22-100007-01	Adapter VGA - DisplayPort 1.1, Delock: 65567
	1	PR22-100008-01	Adapter DVI-I – HDMI, Delock: 65467
	1	840-0758	DisplayPort cable 1,8m
	1	840-0759	DisplayPort cable 3m
	1	840-0760	DisplayPort cable 5m
	1	840-0598	Adapter VGA/DVI
	1	840-0039	VGA/SVGA cable 1,8m/2,0m
	1	840-0273	USB-cable 1,8m, Type A – Type B
	1	840-0134	DVI-cable 2m

3.1.1. Type Label and Product Identification

Product and Package Label, size 85 x 35mm, polyester matt silver.

Figure 2: Type Label

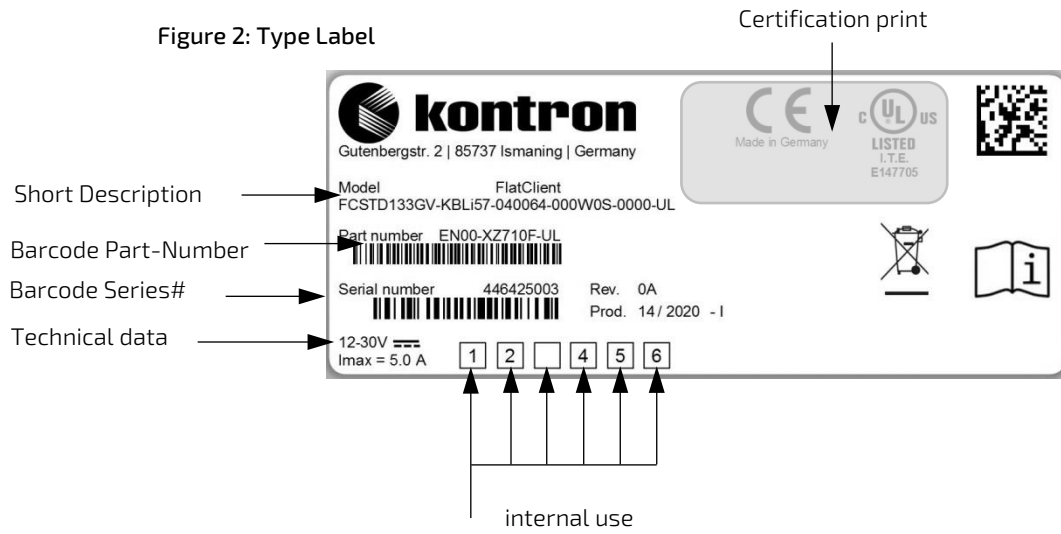

4/ Product Features

4.1. Front Features

Figure 3: Front View Description FlatClient ECO Full-metal

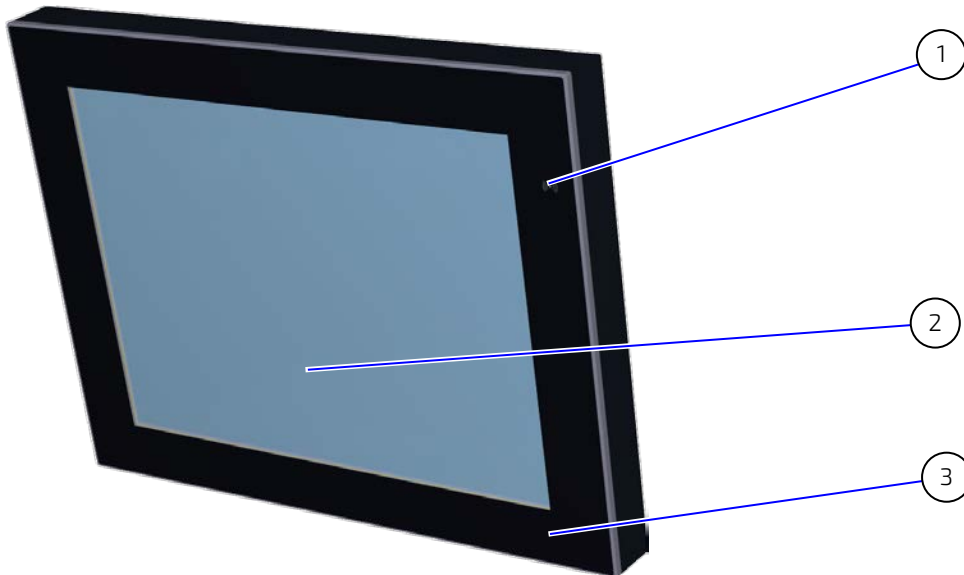

- 1 RFID sign (option)
- 2 TFT Display with resistive touch
- 3 Front plate

4.2. Rear Panel Features

Figure 4: Rear Panel Description – FlatClient ECO (BayTrail) Full-metal variant

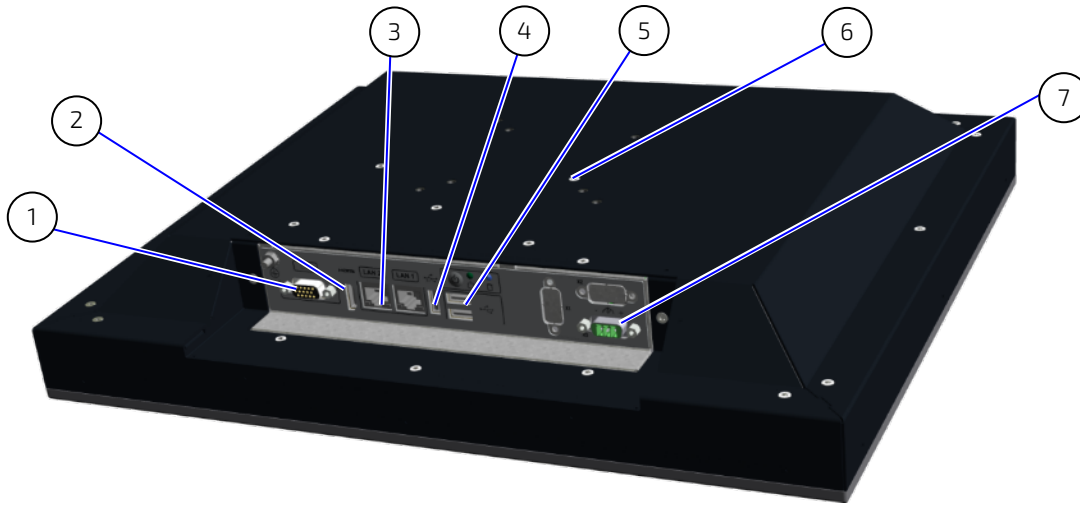

- | | | | |
|---|------------------|---|---------------------|
| 1 | VGA connector | 5 | USB 2.0 2x |
| 2 | HDMI port | 6 | VESA Mounting holes |
| 3 | LAN interface 2x | 7 | Power connector |
| 4 | USB 3.0 | | |

Figure 5: Rear Panel Description – FlatClient PRO (Braswell) built-in variant

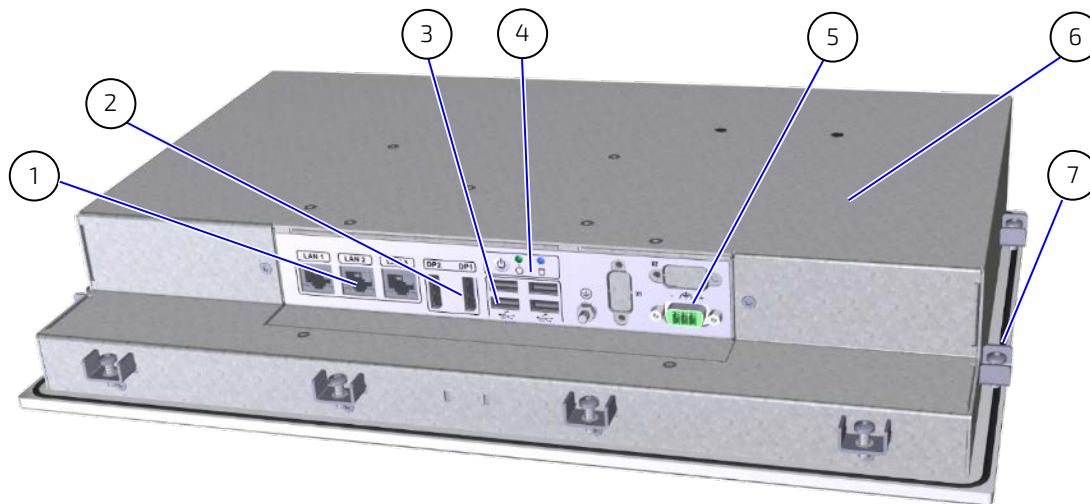

- | | | | |
|---|----------------|---|-----------------|
| 1 | LAN ports 3x | 5 | Power connector |
| 2 | DisplayPort 2x | 6 | Rear cover |
| 3 | USB 3.0 4x | 7 | Mounting Clips |
| 4 | Power/LED | | |

5/ Order Information

EN00-

① ① ② ③ ④ ⑤ ⑥

EN00-	0	0	0	0	0	0	-01		
	Board Generation	Display-Size	Touch-Technology	Mounting variant	Options		internal Revision		
					0	0	4GB RAM/32GB M.2		
					0	1	4GB RAM/64GB M.2		
					0	2	4GB RAM/128GB M.2		
					0	3	4GB RAM/256GB M.2		
					0	4	4GB RAM/512GB M.2		
					0	5	8GB RAM/32GB M.2		
					0	6	8GB RAM/64GB M.2		
					0	7	8GB RAM/128GB M.2		
					0	8	8GB RAM/256GB M.2		
					0	9	8GB RAM/512GB M.2		
					0	A	16GB RAM/32GB M.2		
					0	B	16GB RAM/64GB M.2		
					0	C	16GB RAM/128GB M.2		
					0	D	16GB RAM/256GB M.2		
					0	E	16GB RAM/512GB M.2		
					0	=	Standard Display		
					1	=	1. Display Variant		
					2	=	2. Display Variant		
				1	=	PPC full metal			
				2	=	PPC built-in (open)			
				3	=	Monitor full metal (wo. CPU)			
				4	=	Monitor built-in (wo. CPU)			
				5	=	PPC built-in with service cover			
	0	2	1	x	x	x	RCK mount		
			0	=	with Protection glass				
			1	=	with Touch resistiv				
			2	=	with Touch PCAP				
			3	=	with Protection glass and stainless steel front (STS)				

EN00-	0	0	0	0	0	0	-01			
	Board Generation	Display-Size	Touch-Technology	Mounting variant	Options	Options	internal Revision			
			4	=	with Touch resistiv and stainless steel front (STS)					
			5	=	with Touch PCAP and stainless steel front (STS)					
			6	=	with Touch PCAP V2					
			7	=	with Protection glass V2					
			8	=	Slim with PCAP (V2)					
			9	=	Slim with Protection glass (V2)					
			A	=	Slim with PCAP (V2) and stainless steel front (STS)					
			B	=	Slim with Protection glass (V2) and stainless steel front (STS)					
			C	=	with PMMA and stainless steel front (STS)					
			D	=	with Touch PCAP PMMA and stainless steel front (STS)					
		1	=	10.4"	APL4 Apollolake N4200/J3455					
		2	=	12.1"	APL4 Apollolake N4200/J3455					
		3	=	15.0"	APL4 Apollolake N4200/J3455					
		4	=	15.6"	APL4 Apollolake N4200/J3455					
		5	=	17.0"	APL4 Apollolake N4200/J3455					
		6	=	18.5"	APL4 Apollolake N4200/J3455					
		7	=	19.0"	APL4 Apollolake N4200/J3455					
		8	=	21.5"	APL4 Apollolake N4200/J3455					
		9	=	15.6"	SLU2 Skylake i5-6300U					
		A	=	17.0"	SLU2 Skylake i5-6300U					
		B	=	18.5"	SLU2 Skylake i5-6300U					
		C	=	19.0"	SLU2 Skylake i5-6300U					
		D	=	21.5"	SLU2 Skylake i5-6300U					
		E	=	15.0"	SLU2 Skylake i5-6300U					
		F	=	12.1"	SLU2 Skylake i5-6300U					
		G	=	10.4"	SLU2 Skylake i5-6300U					
		H	=	23.8"	APL4 Apollolake N4200					
		J	=	23.8"	SLU2 Skylake i5-6300U					
		Q	=	7.0"	APL4 Apollolake N4200					Projects only

EN00-	0	0	0	0	0	0	-01		
	Board Generation	Display-Size	Touch-Technology	Mounting variant	Options		internal Revision		
		R	=	7.0"	SLU2 Skylake i5-6300U			Projects only	
		S	=	65.0"	APL4 Apollolake N4200			Projects only	
		T	=	65.0"	SLU2 Skylake i5-6300U			Projects only	
		U	=	10.1"	APL4 Apollolake N4200				
		V	=	10.1"	SLU2 Skylake i5-6300U				
		W	=	12.1"WXGA	APL4 Apollolake N4200				
		X	=	12.1"WXGA	SLU2 Skylake i5-6300U				
		Y	=	13.3"	APL4 Apollolake N4200				
		Z	=	13.3"	SLU2 Skylake i5-6300U				
	Z	=	Baytrail/Haswell						
	Y	=	Apollolake/Skylake						
	X	=	Kaby Lake						
	W	=	Whiskey Lake						

Example: Order-Number EN00-Z11100-01

FlatClient 13.3" with Intel® Skylake i5-6300U resistive touch in full-metal housing with 4 GB RAM/32 GB M.2, no any other options

6/ Product Specification

6.1. Technical Specification

Table 4: Technical Data FlatClient ECO and FlatClient PRO Line

Display Size	7.0"	10.1"	10.4"	12.1" SVGA	12.1" XGA
Resolution (pixel)	800x480	1280x800	800x600, SVGA	800x600, SVGA	1024x768, XGA
Format	0,672916667	16:10	4:3	4:3	4:3
Contrast Ratio	1000:1	800:1	700:1	1500:1	700:1
Brightness	400cd	500cd	400 cd	450 cd	600 cd
Angle View	H160°/V160°	H170°/V170°	H160°/V140°	H178°/V178°	H160°/V140°
Colors	16.2 million	16.2 million	16.7 million	16.7 million	16.2 million
LED Lifetime (> 50%, 25°C)	> 50.000 h	> 50.000 h	> 50.000 h	> 50.000 h	> 50.000 h
Dimensions (WxHxD-mm)	194 x 144 x 55	276 x 195 x 65	297 x 244 x 65	338 x 277 x 65	338 x 277 x 65
Weight	~ 1.4 kg	~ 3.6 kg	~ 3.9 kg	~ 4.7 kg	~ 4.7 kg
Protection glass	X	X	X	X	X
PCAP (Multitouch)	X	X	X	X	X
Resistive touch	On request	On request	X	X	X
Color	RAL 7021 (black anthracite)				
Fastening	VESA 75/75 or 100/100 (full metal housing only); fastening clips (built-in-variant only)				

Table 5: Technical Data FlatClient ECO and FlatClient PRO Line

Display Size	12.1" WXGA	13.3"	15.0"	15.6" HD	15.6" Full HD
Resolution	1280x800, WXGA	1920x1080	1024x768	1366x768, HD	1920x1080, Full HD
Format	16:10	16:9	4:3	16:9	16:9
Contrast Ratio	1000:1	800:1	700:1	500:1	500:1
Brightness	500 cd	400cd	500 cd	300 cd	400 cd
Angle View	H178°/V178°	H178°/V178°	H160°/V140°	H160°/V160°	H140°/V120°
Colors	16.7 million	16.7 million	16.7 million	16.7 million	16.2 million
LED Lifetime (> 50%, 25°C)	> 100.000 h	> 50.000 h	> 50.000 h	> 50.000 h	> 50.000 h
Dimensions (WxHxD-mm)	315 x 228 x 65	360 x 231 x 66	396 x 312 x 69	432 x 281 x 74	432 x 281 x 74
Weight	~ 5.0 kg	~ 4.7 kg	~ 6.4 kg	~ 6.7 kg	~ 6.7 kg
Protection glass	X	X	X	X	X
PCAP (Multitouch)	X	X	X	X	X
Resistive touch	On request	On request	X	X	X
Color	RAL 7021 (black anthracite)				
Fastening	VESA 75/75 or 100/100 (full metal housing only); fastening clips (built-in-variant only)				

Table 6: Technical Data FlatClient ECO and FlatClient PRO Line

Display Size	15.6" Full HD Slim	17.0"	18.5" HD	18.5" Full HD
Resolution	1920x1080, Full HD	1280x1024	1366x768, HD	1920x1080, Full HD
Format	16:9	5:4	16:9	16:9
Contrast Ratio	800:1	800:1	1000:1	1000:1
Brightness	450 cd	350 cd	350 cd	350 cd
Angle View	H140°/V120°	H160°/V140°	H178°/V170°	H178°/V178°
Colors	16.7 million	16.7 million	16.7 million	16.7 million
LED Lifetime (> 50%, 25°C)	> 50.000 h	> 50.000 h	> 50.000 h	> 50.000 h
Dimensions (WxHxD-mm)	399 x 260 x 74	427 x 360 x 74	500 x 321 x 74	500 x 321 x 74
Weight	~ 6.5 kg	~ 7.8 kg	~ 8.6 kg	~ 8.6 kg
Protection glass	X	X	X	X
PCAP (Multitouch)	X	X	X	X
Resistive touch	X	X	X	X
Color	RAL 7021 (black anthracite)			
Fastening	VESA 75/75 or 100/100 (full metal housing only); fastening clips (built-in-variant only)			

Table 7: Technical Data FlatClient ECO and FlatClient PRO Line

Display Size	18.5" FullHD Slim	19.0"	21.5"	21.5" Slim	23.8"
Resolution	1920x1080, FullHD	1280x1024	1920x1080, Full HD	1920x1080, Full HD	1920x1080, Full HD
Format	16:9	5:4	16:9	16:9	16:9
Contrast Ratio	1000:1	1000:1	3000:1	3000:1	1000:1
Brightness	350 cd	350 cd	300 cd	300 cd	250cd
Angle View	H178°/V178°	H170°/V160°	H178°/V178°	H178°/V178°	H178°/V178°
Colors	16.7 million	16.7 million	16.7 million	16.7 million	16.7 million
LED Lifetime (> 50%, 25°C)	> 50.000 h	> 50.000 h	> 50.000 h	> 50.000 h	> 30.000h
Dimensions (WxHxD-mm)	465 x 299 x 74	473 x 396 x 68	575 x 367 x 74	533 x 339 x 74	569 x 357 x 69
Weight	~ 8.4 kg	~ 9.4 kg	~ 10.7 kg	~ 10.5 kg	~ 11.8 kg
Protection glass	X	X	X	X	X
PCAP (Multitouch)	X	X	X	X	X
Resistive touch	X	X	X	X	On request
Color	RAL 7021 (black anthracite)				
Fastening	VESA 75/75 or 100/100 (full metal housing only); fastening clips (built-in-variant only)				

Table 8: Technical Data for FlatClient ECO Line with BayTrail and Braswell processors

CPU	Intel® BayTrail Celeron Quad Core J1900	Option: Intel® Braswell Celeron Quad Core N3150(DT)
Memory	4GB DDR3 SO-DIMM	
BIOS	AMI uEFI BIOS	
I/O Standard	2xGbE (1x Intel® I210, 1x Realtek RTL8111G), 1x HDMI, 1x VGA, 1x USB3.0, 2x USB2.0	2xGbE (2x Intel® I210), 1x HDMI, 1x DP, 4x USB3.0, 1x VGA, 2x USB2.0 (option)
Power Supply	12 to 30 VDC Input	
max. Input current	5 A	
Cooling	Fanless passive cooling	
Operating Temperature	0°C - 50°C ambient	
OS Support	Windows7 incl Embedded, Windows 8.1 incl Embedded, Linux	Windows7 incl Embedded, Windows8.1 incl Embedded, Windows10, Linux
Certification	CE, cULus	CE
Protection class	Front: IP65, Housing IP20	
Trusted Platform Module (TPM)	not available	
Options	8 GB RAM, CF/SD Card Adapter, SD Card Memory 4 GB, 16 GB, 32 GB, 64 GB, CF Card Memory on demand, mSATA SSD 32 GB, 64 GB, 128 GB, 2x COM (RS232, RS422, RS485), Audio with amplifier (2x 3 W), RFID, WiFi (on demand)	

Table 9: Current Rating at 12 V for FlatClient ECO Line with Intel® Celeron Quad Core J1900

Display Size	Current [A]
7.0"	1.9 A
10.1"	2.0 A
10.4"	2.2 A
12.1" (800x600)	2.5 A
12.1" (1024x768)	2.8 A
12.1" (1280x800)	2.5 A
13.3" (1920x1080)	3.0 A
15.0"	2.7 A
15.6"	2.9 A
17.0"	3.6 A
18.5"	3.5 A
19.0"	3.4 A
21.5"	3.7 A
23.8"	3.5 A

Table 10: Technical Data FlatClient ECO Line with Intel® Pentium® CPU N4200/Intel® Celeron® J3455

CPU	Intel® Pentium® CPU N4200/Intel® Celeron® J3455
Memory	4 GB DDR3L
BIOS	AMI uEFI BIOS
Hardware Monitor	Temperature, Voltages
Watchdog	Programmable WDT to generate System reset event
Realtime Clock (RTC)	Processor integrated RTC
I/O Standard	2xGbE (RJ-45 on rear, Intel® I210-AT), 4x USB3.0, 1x DP, 1x HDMI
Power Supply	12 to 30 VDC Input
max. Input current	5 A
Cooling	Fanless passive cooling
Operating Temperature	0°C - 50°C ambient
OS Support	Windows 10 IoT, Linux Ubuntu
Certification	CE, FCC Class A, UL Canada
Protection class	Front: IP65, Housing IP20
Trusted Platform Module (TPM)	not available
Options	CF/SD Card Adapter, SD Card Memory 4GB, 16GB, 32 GB, 64 GB, CF Card Memory on demand, m.2 SSD 32 GB, 64 GB, 128 GB, 256 GB, 512 GB, 2x COM (RS232, RS422, RS485), Audio with amplifier (2x 3W), RFID, WiFi (on demand)

Table 11: Current Rating at 12 V for FlatClient ECO Line with Intel® Pentium® CPU N4200/Intel® Celeron® J3455

Display Size	Current [A]
10.1"	3.1 A
10.4"	3.2 A
12.1" (800x600)	3.5 A
12.1" (1024x768)	3.9 A
12.1" (1280x800)	3.6 A
13.3" (1920x1080)	4.0 A
15.0"	3.8 A
15.6"	3.9 A
17.0"	4.7 A
18.5"	4.6 A
19.0"	4.5 A
21.5"	4.7 A
23.8"	4.6 A

Table 12: Technical Data FlatClient PRO Line with Haswell and Broadwell processors

CPU	Intel® Haswell ULT i5-4300U	Option: Intel® Broadwell ULT i5-5350U
Memory	4 GB DDR3 SO-DIMM	
BIOS	AMI uEFI BIOS	
Hardware Monitor	Temperature, Voltages	
Watchdog	Programmable WDT to generate System reset event	
Realtime Clock (RTC)	Processor integrated RTC	
I/O Standard	2xGbE (1x Intel® I210, 1x Realtek RTL8111G), 4x USB3.0	
Power Supply	12 to 30 VDC Input	
max. Input current	5 A	
Cooling	Fanless passive cooling	
Operating Temperature	0°C - 50°C ambient (UL listed 0°C - 45°C)	0°C - 45°C ambient
OS Support	Windows7 incl Embedded, Windows8.1 incl Embedded, Linux, Windows XP (limited)	
Certification	CE, cULus	CE
Protection class	Front: IP65, Housing IP20	
Trusted Platform Module (TPM)	not available	
Options	8 GB RAM, CF/SD Card Adapter, SD Card Memory 4GB, 16GB, 32GB, 64GB, CF Card Memory on demand, mSATA SSD 32GB, 64GB, 128GB, 2x COM (RS232, RS422, RS485), Audio with amplifier (2x 3W), RFID, WiFi (on demand)	

Table 13: Current Rating at 12 V for FlatClient PRO Line with Intel® Haswell ULT i5-4300U

Display Size	Current [A]
10.1"	3.2 A
10.4"	3.4 A
12.1" (800x600)	3.7 A
12.1" (1024x768)	4.0 A
12.1" (1280x800)	3.7 A
13.3" (1920x1080)	4.2 A
15.0"	3.9 A
15.6"	4.1 A
17.0"	4.8 A
18.5"	4.7 A
19.0"	4.6 A
21.5"	4.9 A
23.8"	4.7 A

Table 14: Technical Data FlatClient PRO Line with Skylake, Whiskey Lake and Kaby Lake CPU

CPU	Intel® Skylake ULT Core™ i5-6300U	Intel® Kaby Lake ULT Core™ i5-7300U	Intel® Whiskey Lake Core™ i5-8365UE
Memory	4 GB DDR4 SO-DIMM		
BIOS	AMI uEFI BIOS		
Hardware Monitor	Temperature, Voltages		
Watchdog	Programmable WDT to generate System reset event		
Realtime Clock (RTC)	Processor integrated RTC		
I/O Standard	2xGbE, 1x DP, 4x USB3.0		
Power Supply	12 to 30 VDC Input		
max. Input current	5 A		
Cooling	Fanless passive cooling		
Operating Temperature	0°C - 50°C ambient (UL listed 0°C - 45°C)		
OS Support	Windows7 incl Embedded, Windows 10 IoT, Linux Ubuntu		
Certification	CE, cULus, Design to meet FCC		
EMC	EN55022 class B		
Protection class	Front: IP65, Housing IP20		
Trusted Platform Module (TPM)	available		
Options	8 or 16 GB RAM, CF/SD Card Adapter, SD Card Memory 4GB, 16GB, 32GB, 64GB, CF Card Memory on demand, M.2 SSD 32GB, 64GB, 128GB, 2x COM (RS232, RS422, RS485), Audio with amplifier (2x 3W), RFID, WiFi (on demand)		

Table 15: Current Rating at 12 V for FlatClient PRO Line with Intel® Core™ i5-6300U/Core™ i5-7300U/Core™ i5-8365UE

Display Size	Current [A]
10.1"	3.5 A
10.4"	3.6 A
12.1" (800x600)	3.9 A
12.1" (1024x768)	4.3 A
12.1" (1280x800)	4.0 A
13.3" (1920x1080)	4.4 A
15.0"	4.2 A
15.6"	4.4 A
17.0"	5.0 A
18.5"	5.0 A
19.0"	4.9 A
21.5"	5.0 A
23.8"	5.0 A

6.2. Environmental Specification

Table 16: Environmental Specification FlatClient ECO and FlatClient PRO Line

Operating Altitude	Up to 3000 m (9900 ft)
Storage Altitude	Up to 5000 m (16500 ft)
Humidity	10%-90% @ 39°C, non condensing
Certification	CE, cULus (only for Haswell and BayTrail CPU)
Protection Class	Front: IP65, Housing IP20
Shock, according to EN 60068-2-27	15 G 11 ms duration (half sine)
Vibration, according to EN 60068-2-6	10-500 Hz: 1G/3 axis

NOTICE

FlatClient is intended for indoor use only. To avoid product damage do not use in a sheltered outdoor, outdoor or sunlit environment.

Observe that the product is not exposed to direct sunlight (UV radiation):

- Prolonged exposure shortens field life and voids the warranty
- Short exposure may lead to higher temperatures inside the product and cause permanent damage
- Direct exposure accelerates long-term aging

For intend use in an outdoor environment or a sunlit environment, contact your Kontron representative.

6.3. Power Specification

Before connecting the FlatClient to an external DC power supply, ensure that the external DC power supply meets the electrical specification on the product's Type Label (see, Figure 2) and as specified in Table 8, Table 10, Table 12, and Table 14. The external DC power supply must automatically recover from AC power loss and startup under peak loading.

CAUTION

Only connect the product to an external power supply providing the voltage type (AC or DC) and the input power (max. current) specified on the Kontron Product Label.

The external power supply must meet the requirements of ES1/PS2 according to IEC/UL 62368-1.

Connectez le produit uniquement à une alimentation externe fournissant le type de tension (AC ou DC) et la puissance d'entrée (courant max.) spécifiés sur l'étiquette du produit Kontron. L'alimentation externe doit répondre aux exigences de ES1/PS2 selon IEC/UL 62368-1.

The external DC power supply must incorporate protection and supply features such as over current, over temperature, over voltage and brownout protection, to protect the FlatClient against fluctuations and interruptions and ensure operation without loss of data or product damage.

NOTICE

To protect the product and any connected peripherals, make sure that the power cables have the right diameter to withstand the maximum available current.

NOTICE

If there is an unintentional voltage drop in the mains power supply for longer than the specified holdup time (brownout), all supply voltages should be shut down and remain in the off state long enough to allow internal voltages to discharge sufficiently. During the off state time do not disconnect or add cables to/from the I/O connectors. Failure to observe the off state time means that parts of the product or attached peripherals may work incorrectly or suffer a reduction of MTBF.

The minimum off state time, to allow internal voltages to discharge, depends on the power supply used and additional electrical factors. To determine the required off state time, each case must be considered individually. For more information, contact [Kontron Support](#).

6.4. Compliance

If modified, the prerequisites for specific approvals may no longer apply. Kontron is not responsible for any radio television interference caused by unauthorized modifications of the product or the substitution or attachment of connecting cables and equipment other than those specified by Kontron. The correction of interference caused by such unauthorized modification, substitution or attachment will be the responsibility of the user.

Table 17: Compliance

Low Voltage Directive (Electrical Safety)	2014/35/EU
EMC Directive	2014/30/EU
RoHS II Directives	E2011/65/EU + 2015/863/EU + 2017/2102/EU
Safety	EN62368-1:2014 + AC:2015 Audio/video, information and communication technology equipment – Part 1: Safety requirements (IEC 62368-1:2014, modified + Cor.:2015)
EMC	EN55032:2015 Information technology equipment, Radio disturbance characteristics, Limits and methods of measurement (CISPR 32:2015) EN61000-6-2:2005 + Cor.:2005 Electromagnetic compatibility (EMC), Part 6-2: Generic Standards – Immunity for industrial environments+ CENELEC- Cor.:2005

7/ Mechanical Specification

7.1. 7.0" Built-in Variant

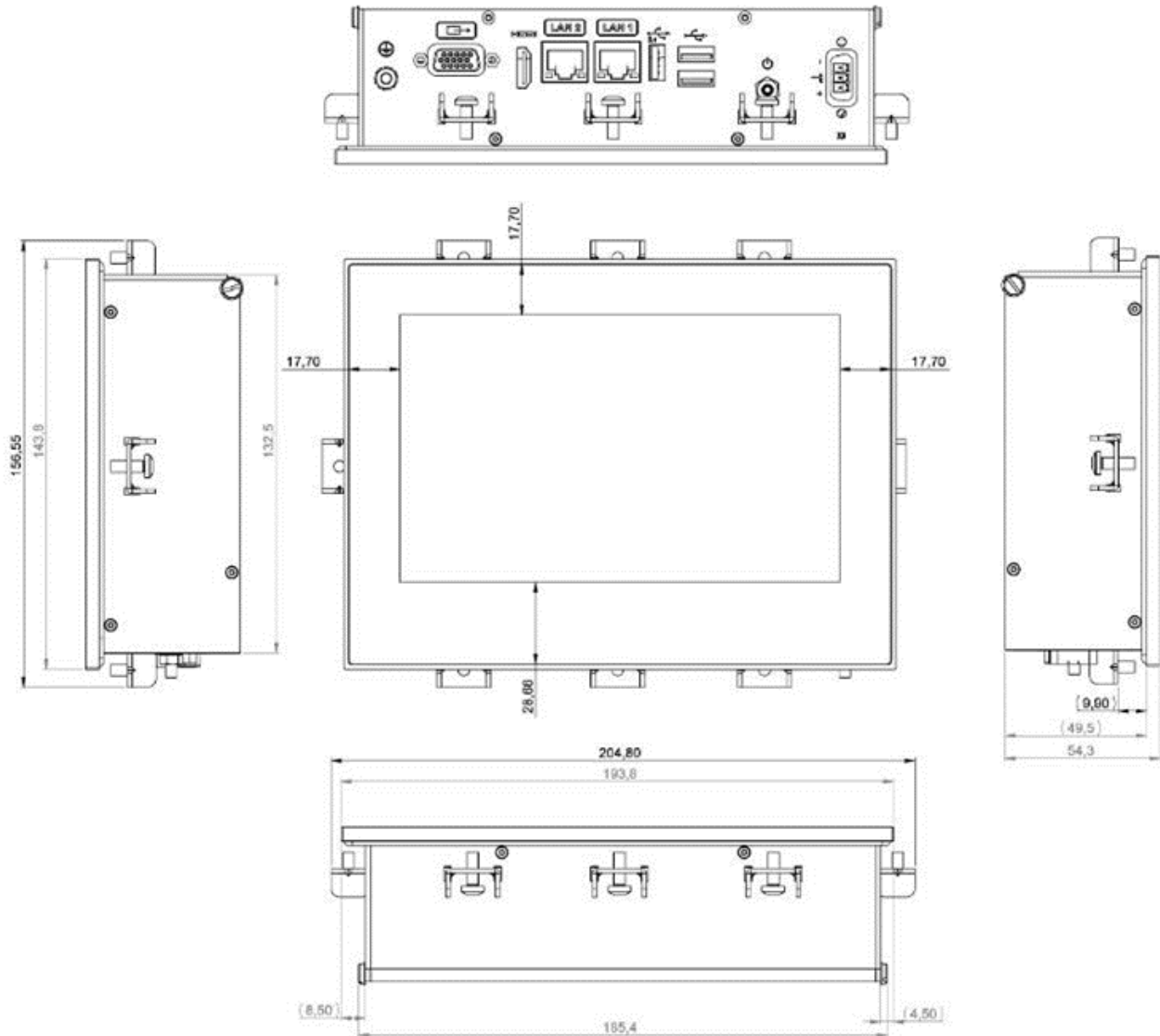

7.2. 7.0" Panel Cutout Dimensions

The built-in monitor's panel cutout dimensions are:

- ▶ Horizontal: 187 mm [7.362"]
- ▶ Vertical: 138.5 mm [5.452"]

7.3. 10.1" Built-in Variant

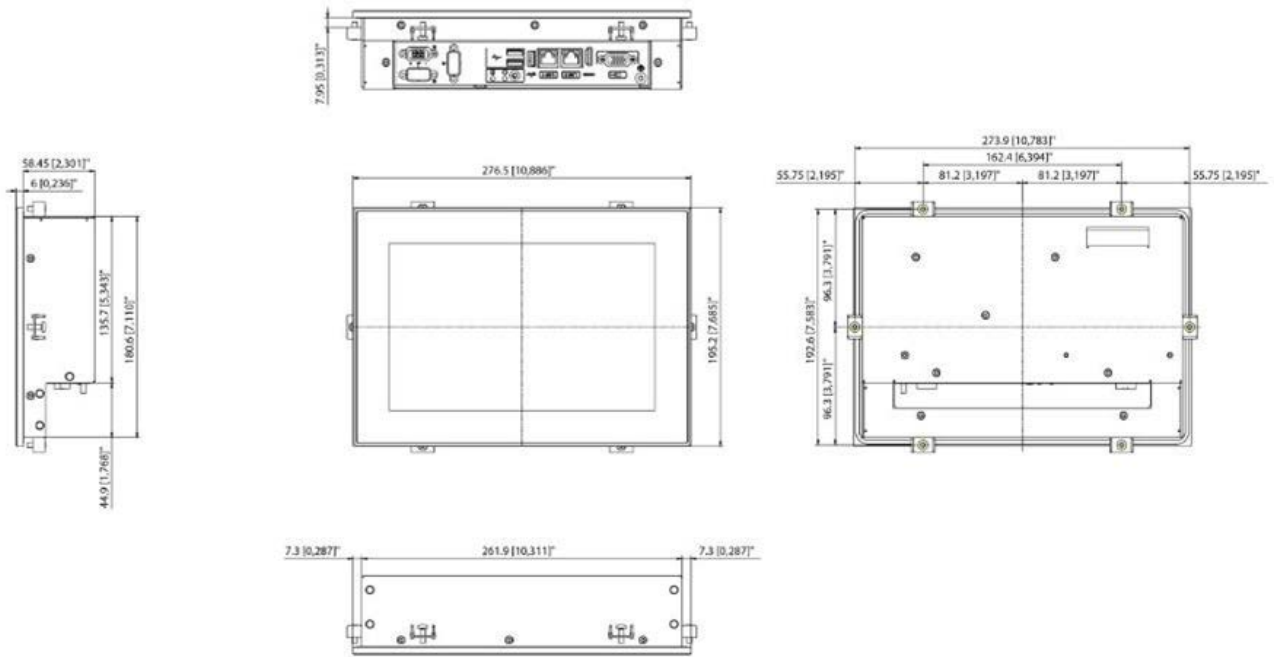

7.3.1. 10.1" Panel Cutout

The built-in monitor's panel cutout dimensions are:

- ▶ Horizontal: 263.9 mm [10.390"]
- ▶ Vertical: 182.6 mm [7.189"]

7.4. 10.1" Full-metal Variant

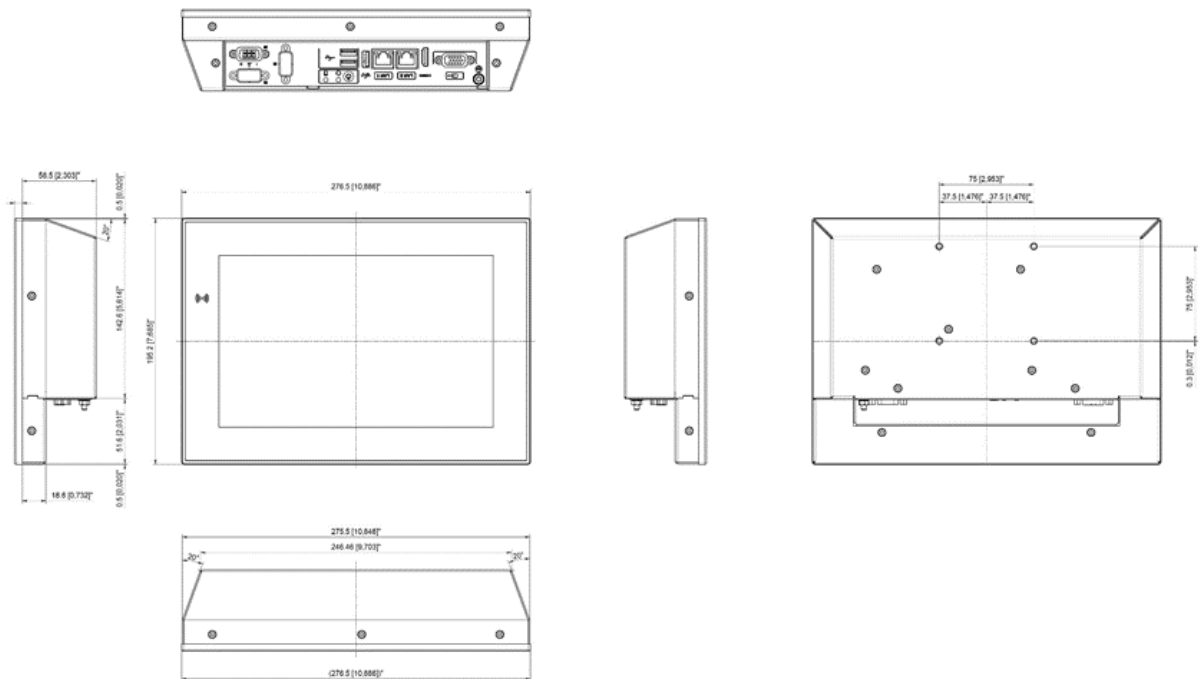

7.5. 10.4" Built-in Variant

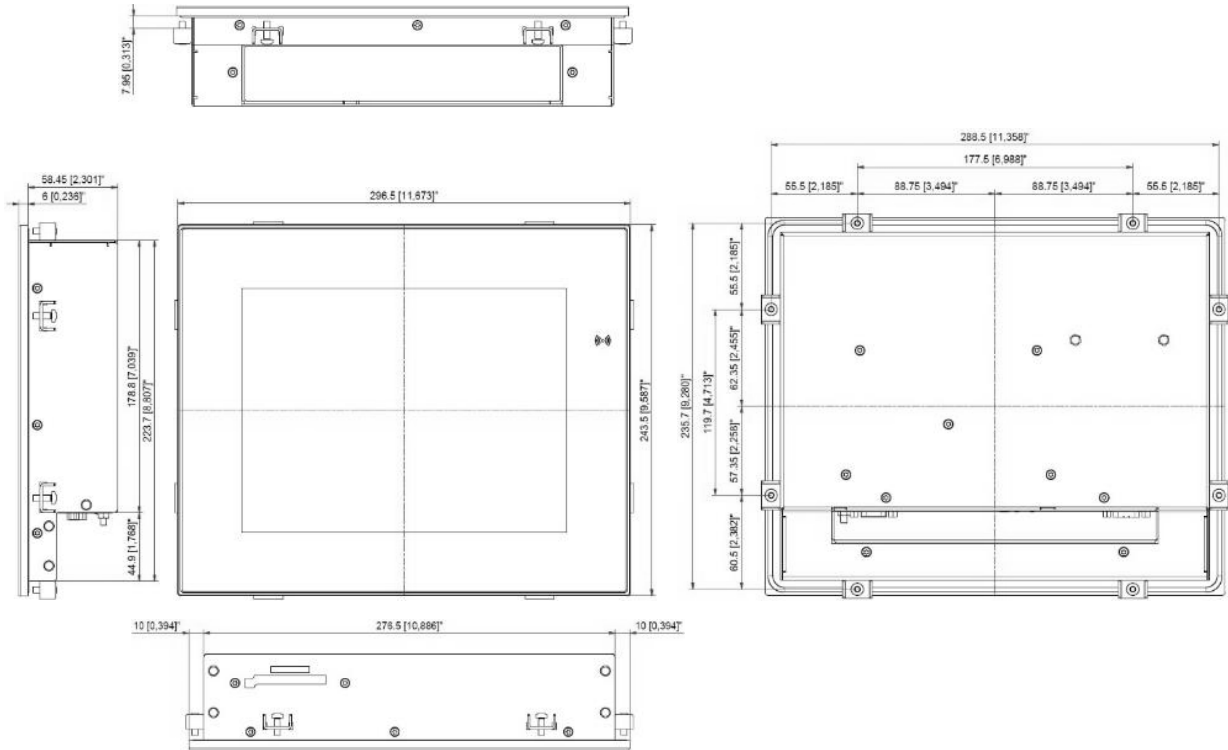

7.5.1. 10.4" Panel Cutout

The built-in monitor's panel cutout dimensions are:

- ▶ Horizontal: 278.5 mm [10.965"]
- ▶ Vertical: 223.7 mm [8.886"]

7.6. 10.4" Full-metal Variant

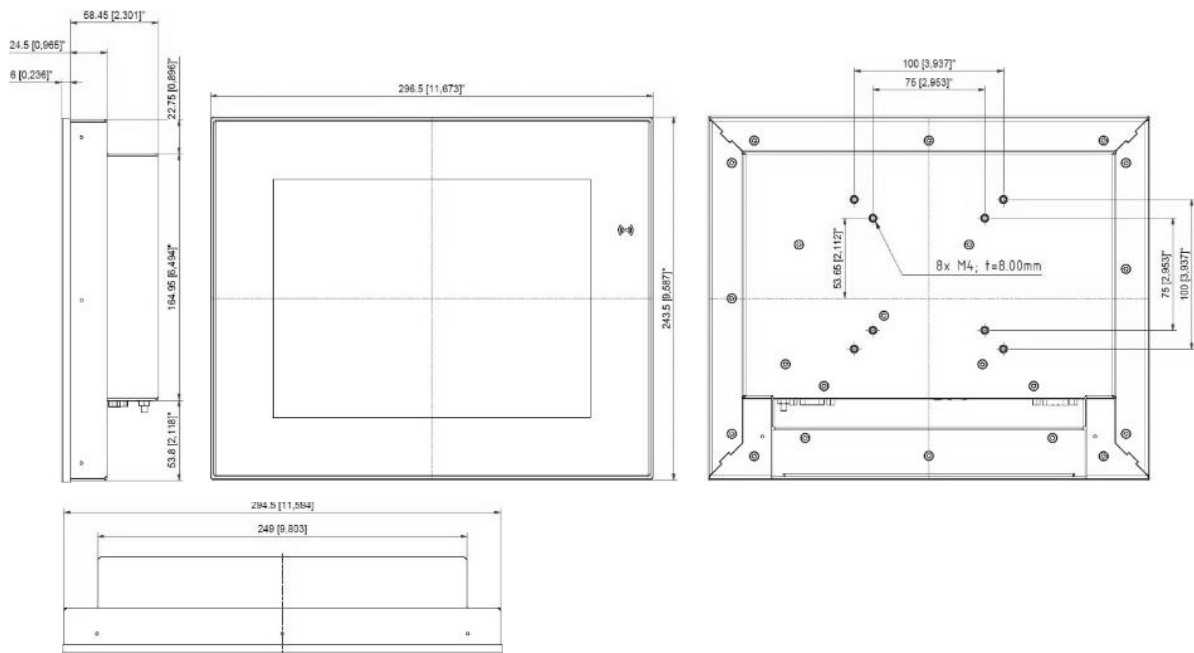

7.7. 12.1" Built-in Variant WXGA (1280x800)

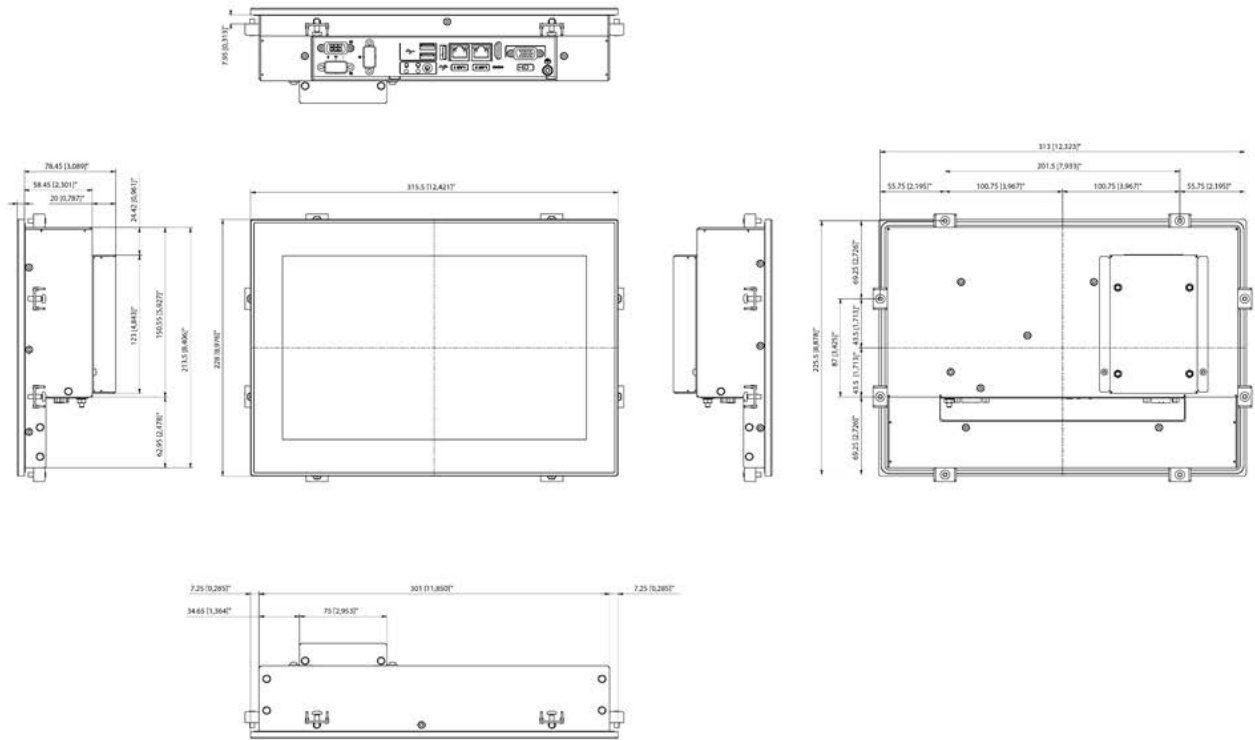

7.7.1. 12.1" WXGA Panel Cutout

The built-in monitor's panel cutout dimensions are:

- ▶ Horizontal: 303 mm [11.929"]
- ▶ Vertical: 215.5 mm [8.484"]

7.8. 12.1" Full-metal Variant WXGA (1280x800)

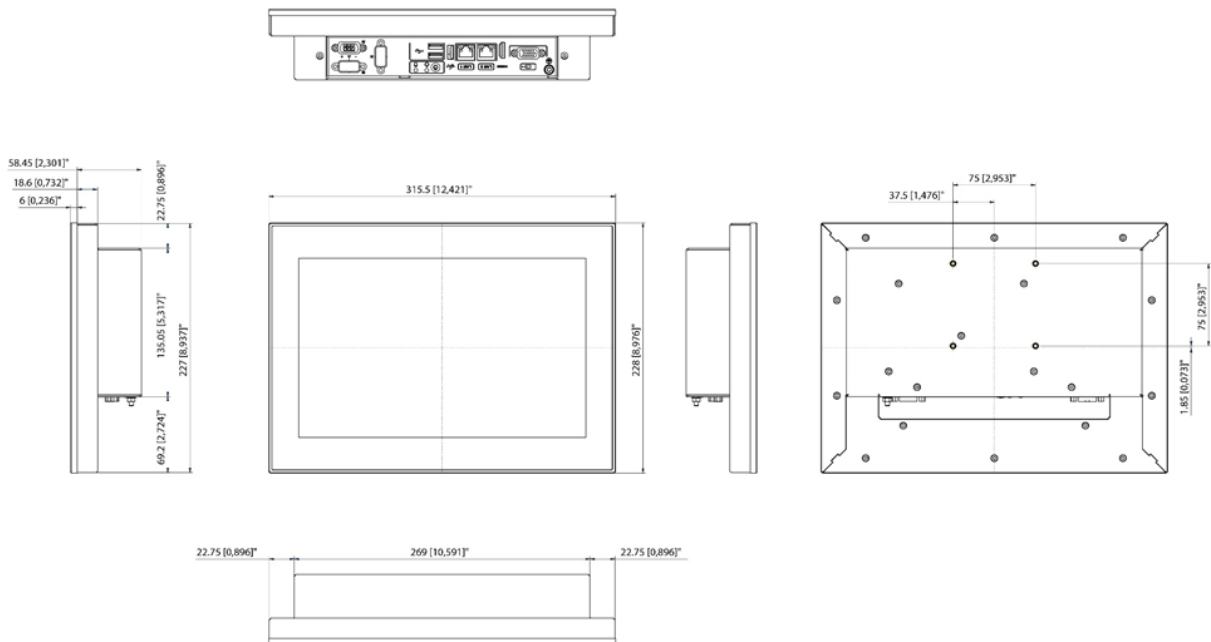

7.9. 12.1" Built-in Variant SVGA and XGA (800x600, 1024x768)

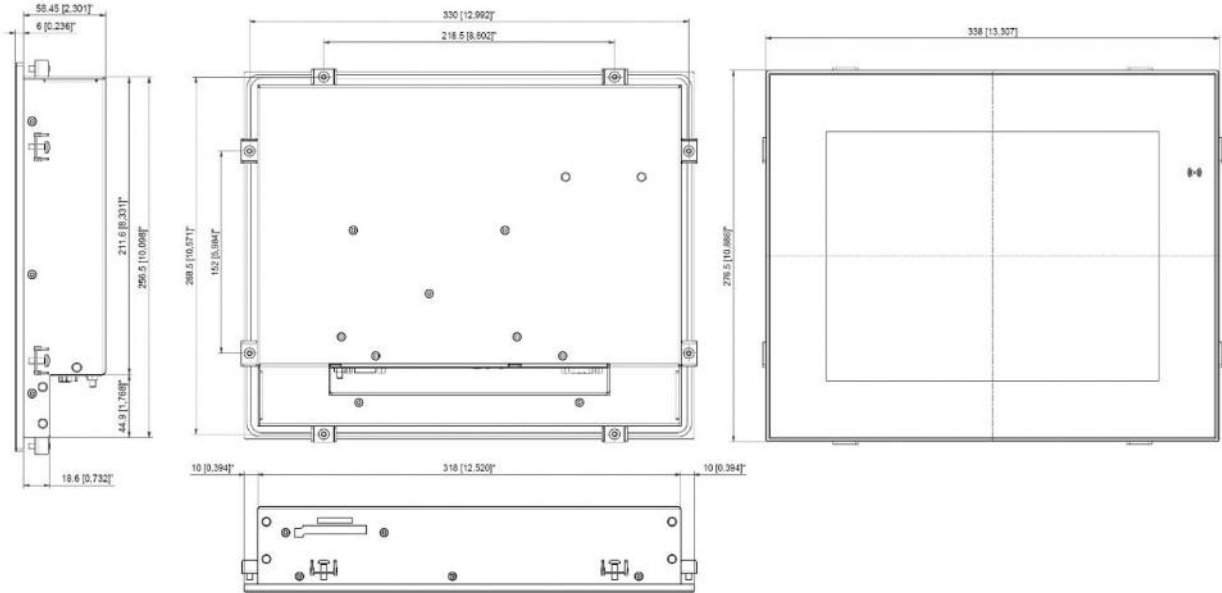

7.9.1. 12.1" Panel Cutout

The built-in monitor's panel cutout dimensions are:

- ▶ Horizontal: 320 mm [12.598"]
- ▶ Vertical: 258.5 mm [10.177"]

7.10. 12.1" Full-metal Variant SVGA and XGA (800x600, 1024x768)

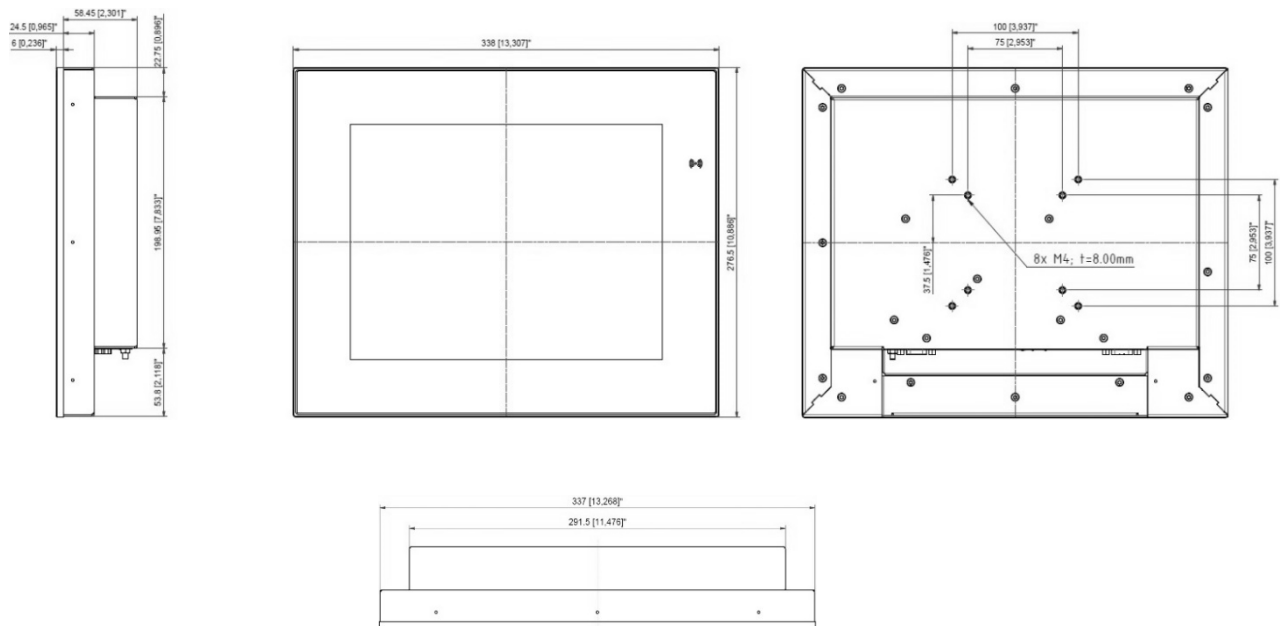

7.11. 13.3" Built-in Variant

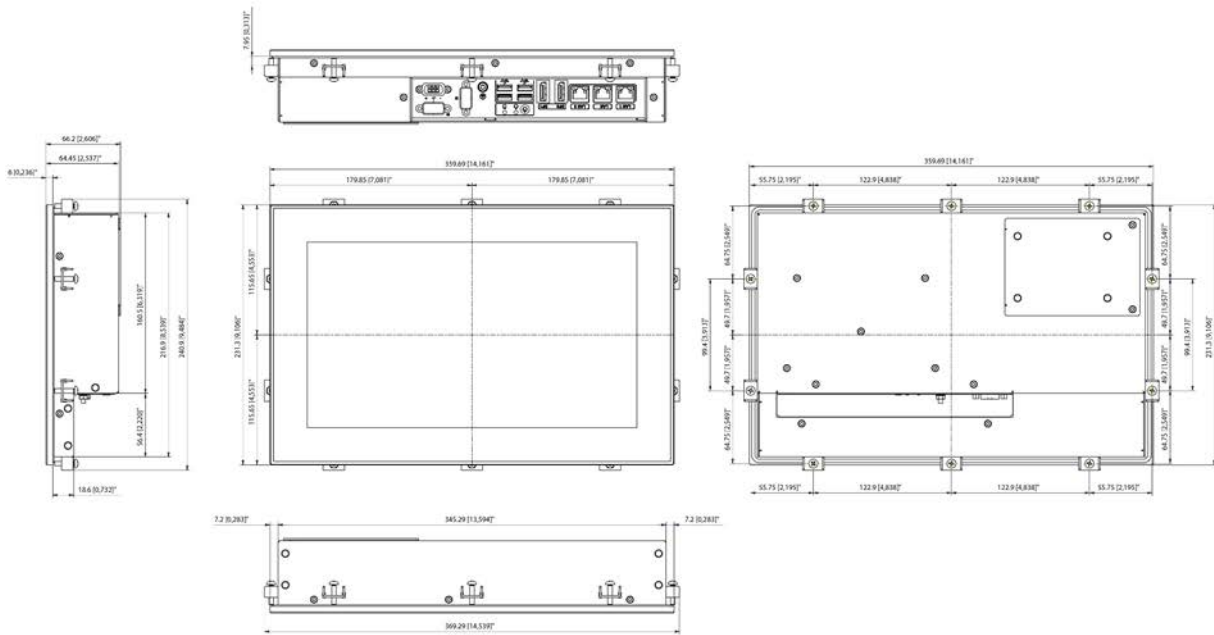

7.11.1. 13.3" Panel Cutout

The built-in monitor's panel cutout dimensions are:

- ▶ Horizontal: 347.29 mm [13.673"]
- ▶ Vertical: 218.9 mm [8.618"]

7.12. 13.3" Full-metal Variant

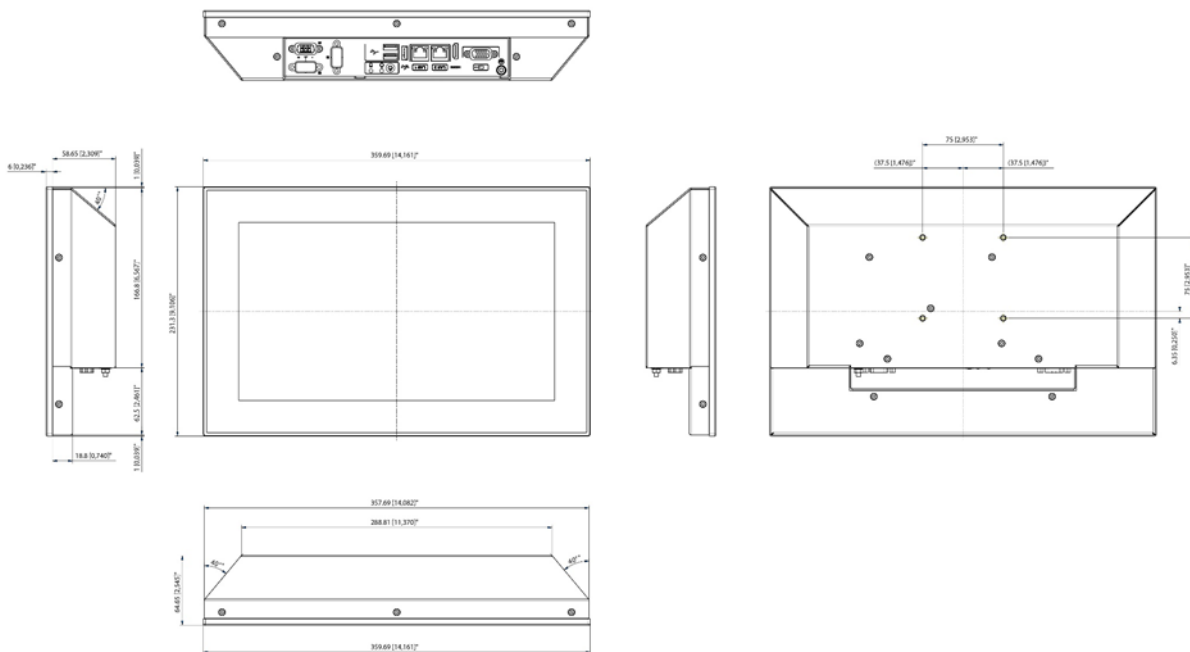

7.13. 15.0" Built-in Variant

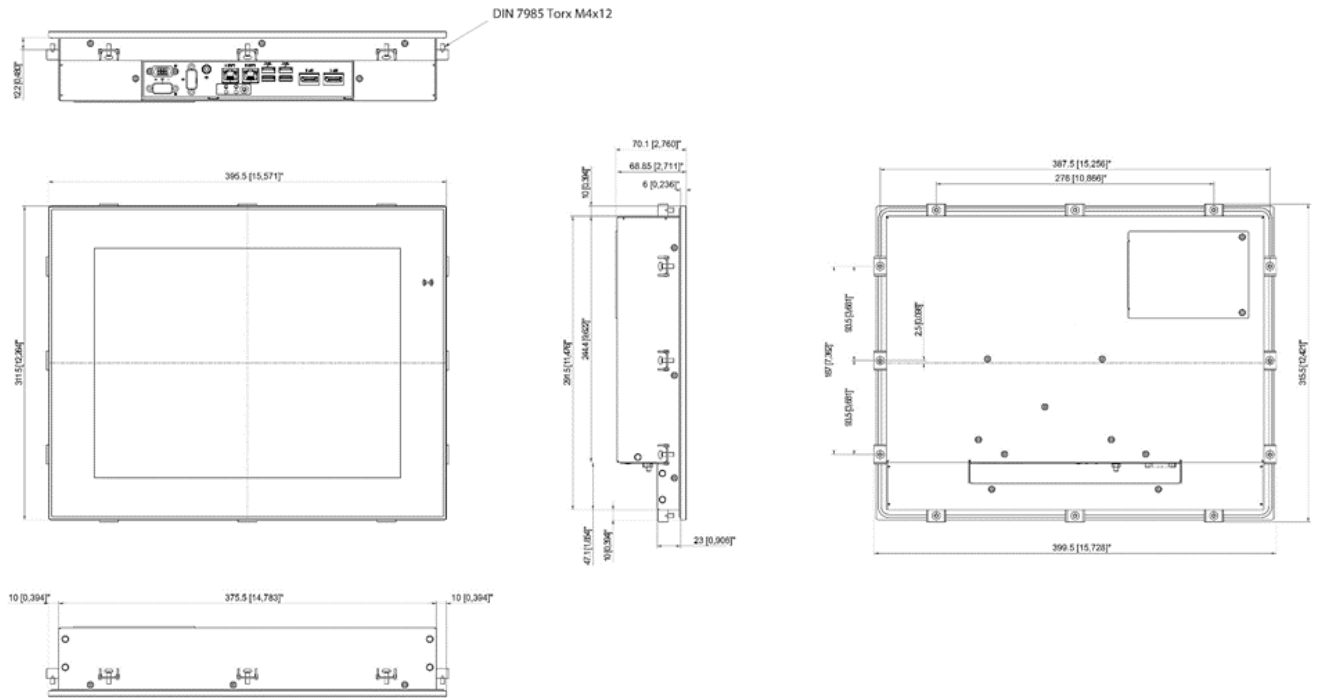

7.13.1. 15.0" Panel Cutout

The built-in monitor's panel cutout dimensions are:

- ▶ Horizontal: 377.5 mm [14.862"]
- ▶ Vertical: 293.5 mm [11.555"]

7.14. 15.0" Full-metal VESA Variant

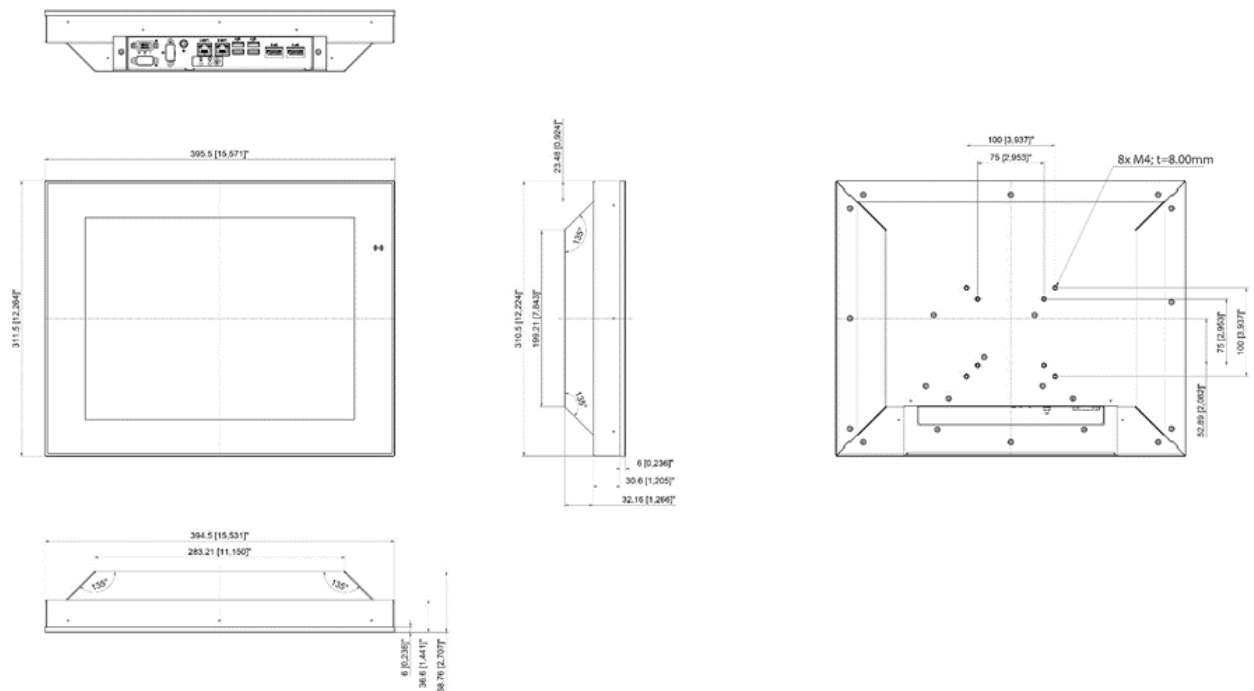

7.15. 15.6" Built-in Variant

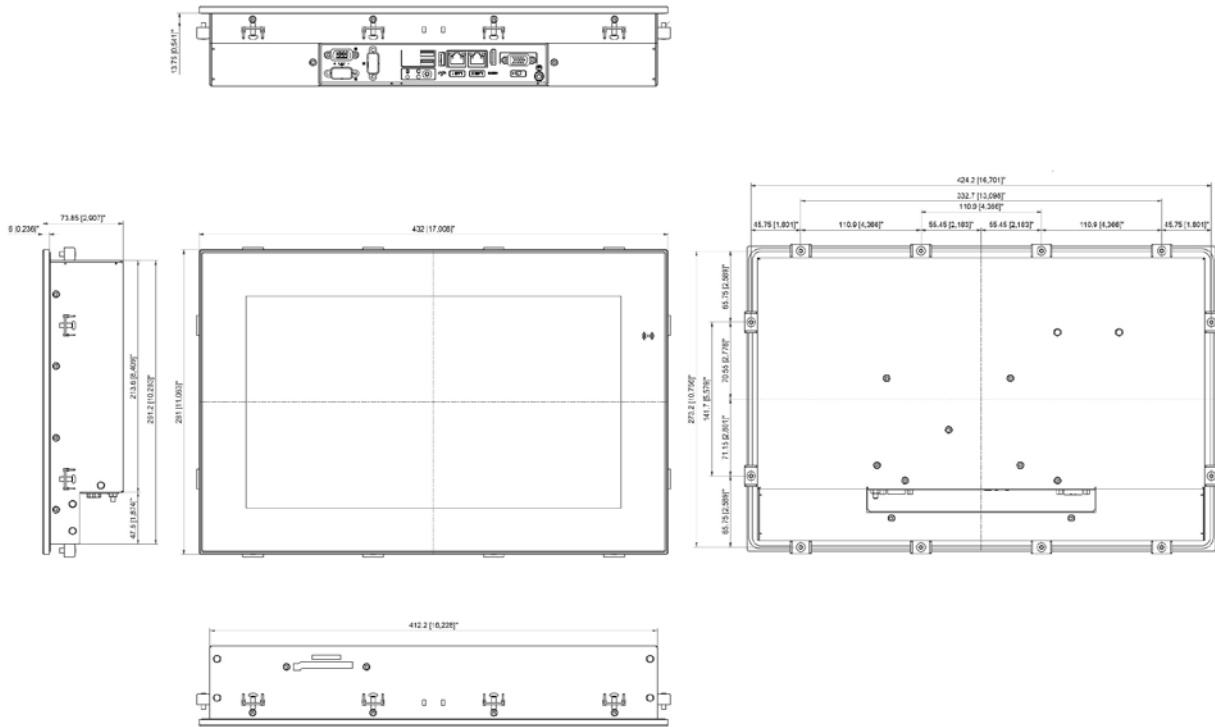

7.15.1. 15.6" Panel Cutout

The built-in monitor's panel cutout dimensions are:

- ▶ Horizontal: 414.2 mm [16.307"]
- ▶ Vertical: 263.2mm [10.362"]

7.16. 15.6" Built-in Slim Variant

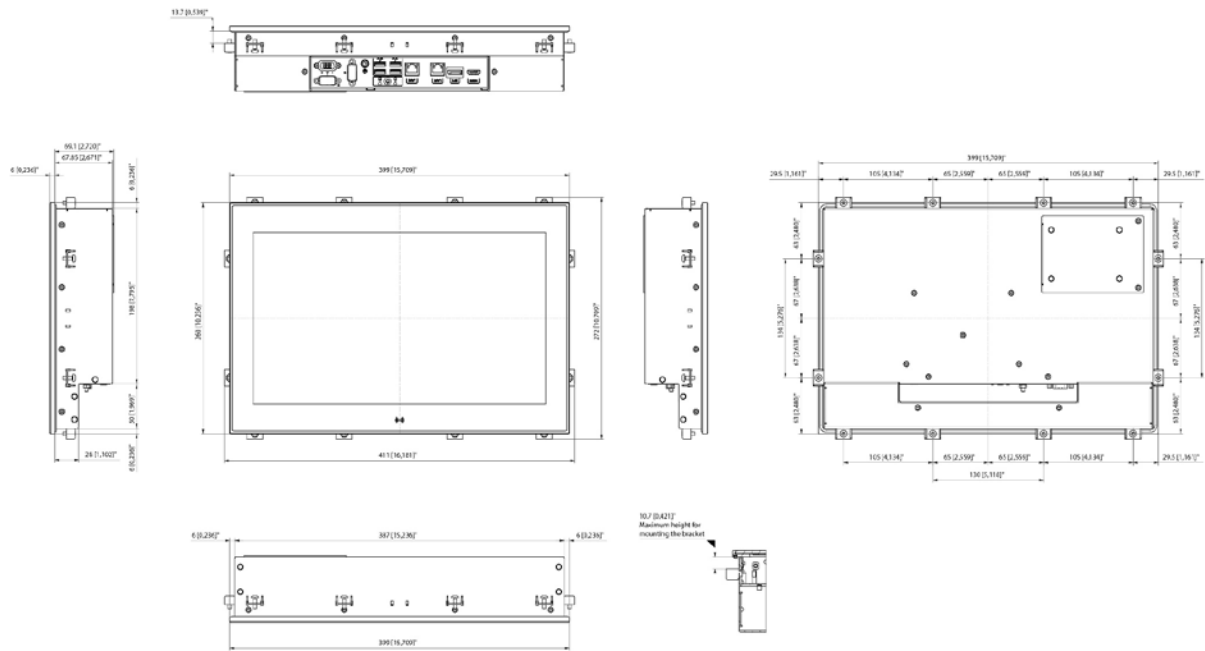

7.16.1. 15.6" Built-in (slim) Panel Cutout

The built-in monitor's panel cutout dimensions are:

- ▶ Horizontal: 389 mm [15.315"]
- ▶ Vertical: 250 mm [9.842"]

7.17. 15.6" Full-metal Variant

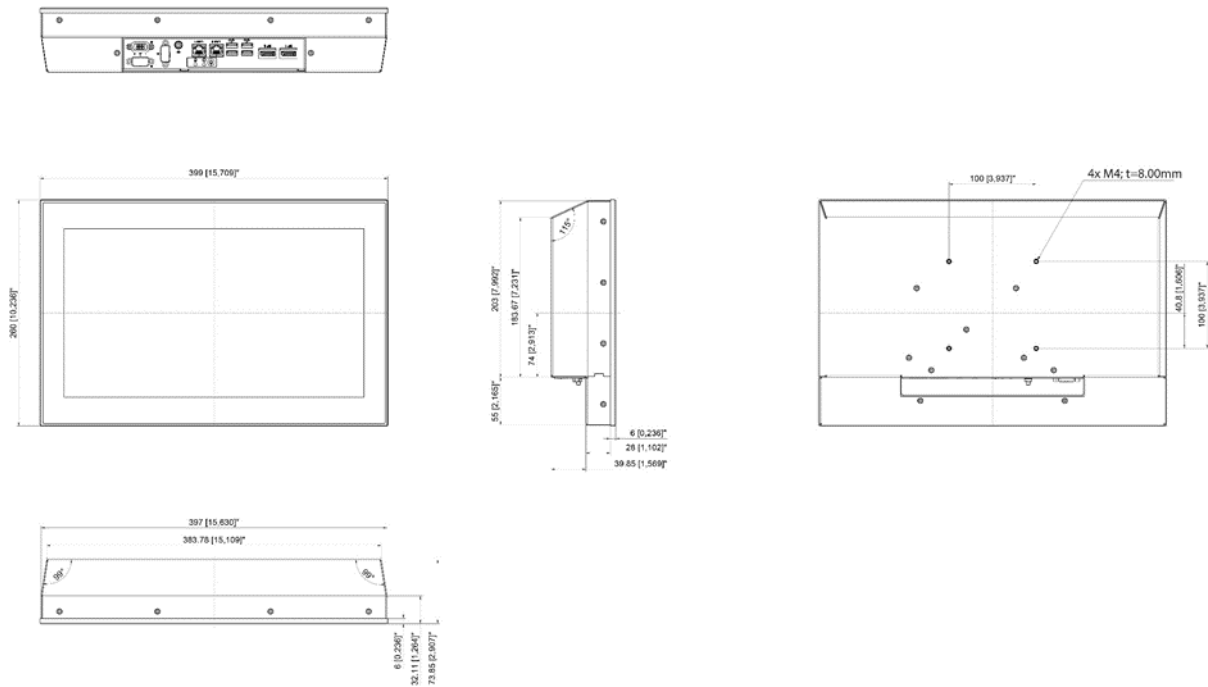

7.18. 15.6" VESA Slim Variant

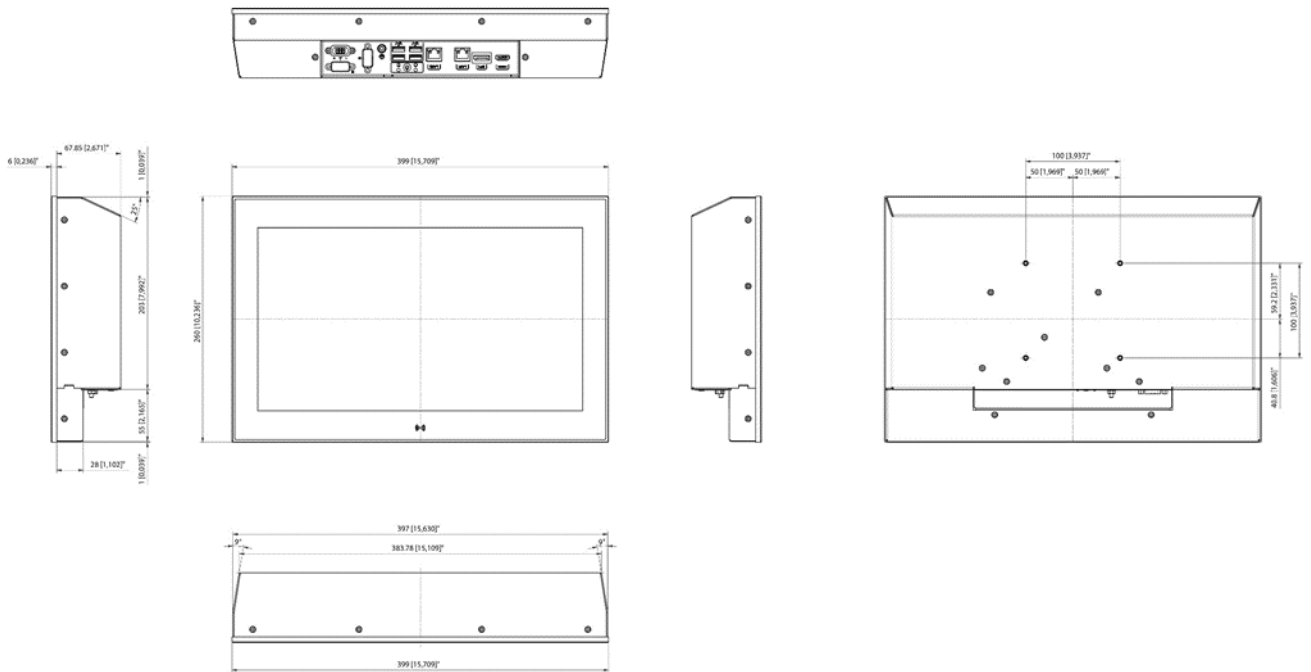

7.19. 17.0" Built-in Variant

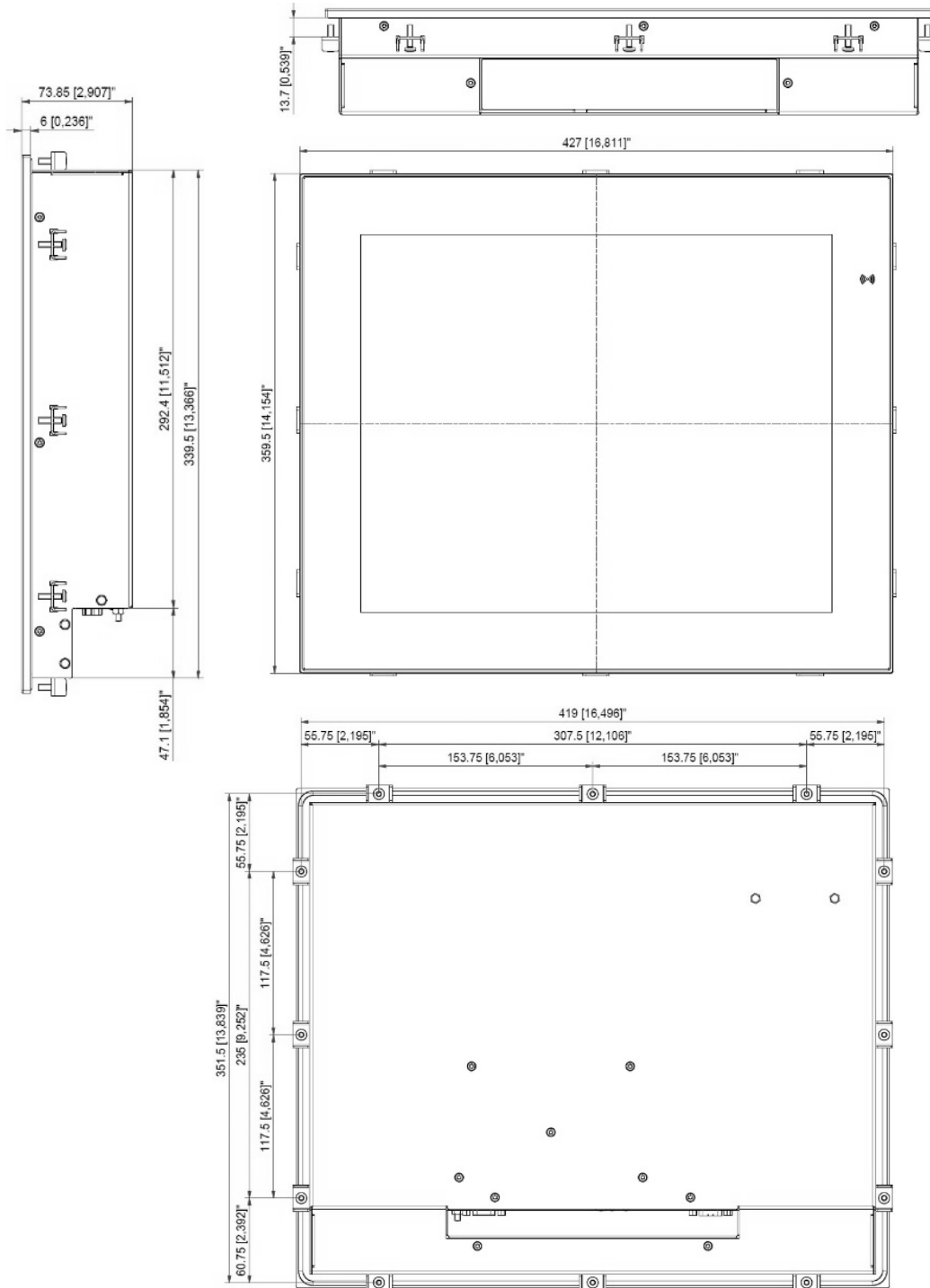

7.19.1. 17.0" Panel Cutout

The built-in monitor's panel cutout dimensions are:

- ▶ Horizontal: 409 mm [16.102"]
- ▶ Vertical: 341.5 mm [13.445"]

7.20. 17.0" Full-metal Variant

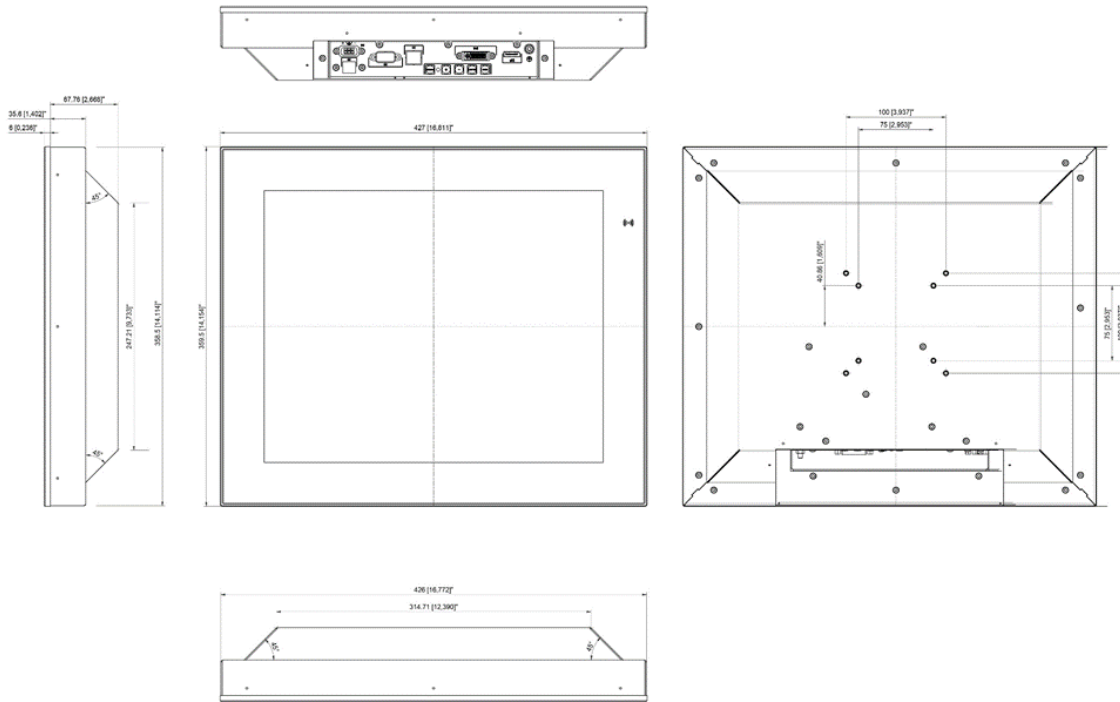

7.21. 18.5" Built-in Variant (HD and FullHD)

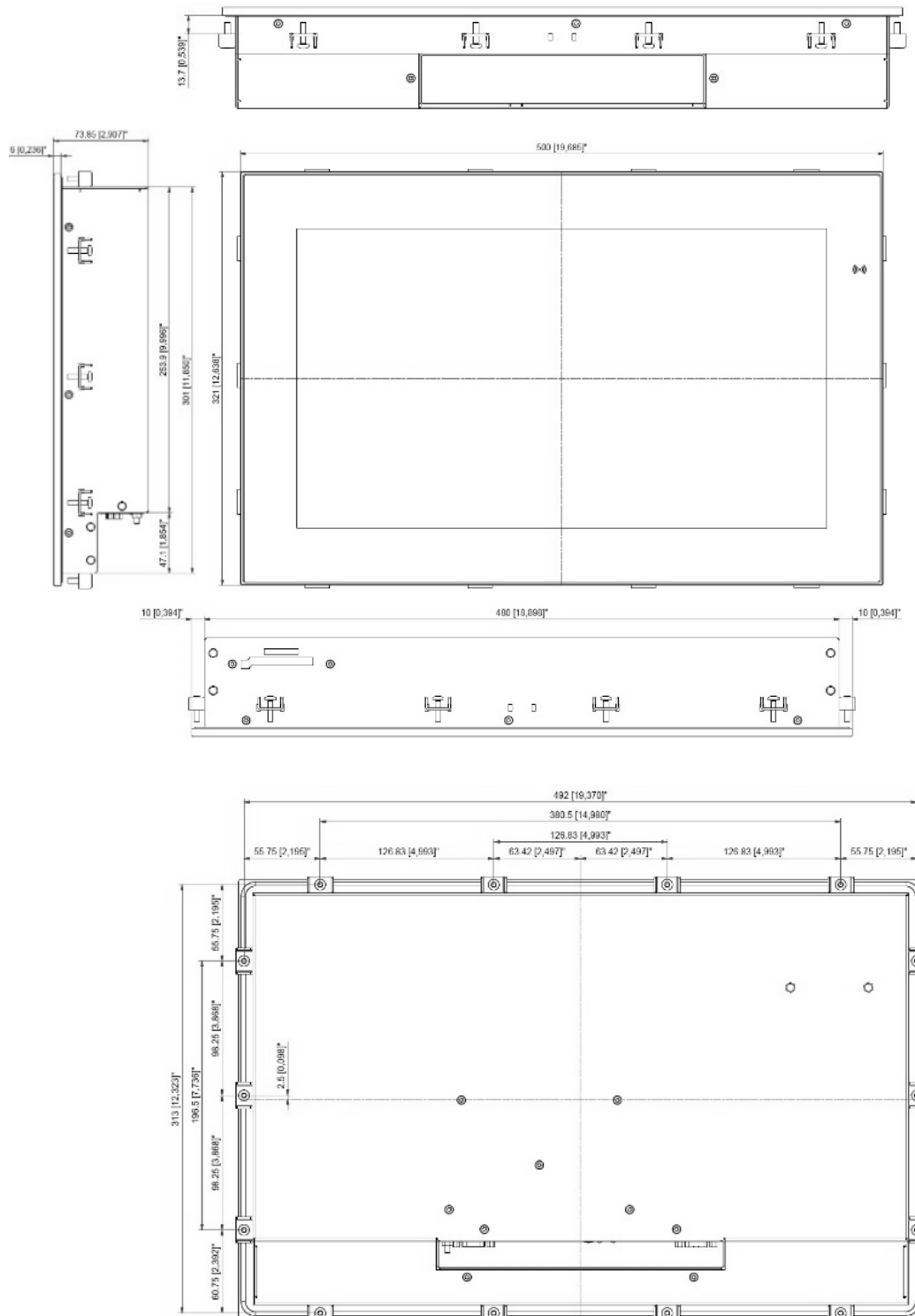

7.21.1. 18.5" Panel Cutout

The built-in monitor's panel cutout dimensions are:

- ▶ Horizontal: 482.5 mm [18.996"]
- ▶ Vertical: 303 mm [11.929"]

7.22. 18.5" Built-in Slim Variant (HD and FullHD)

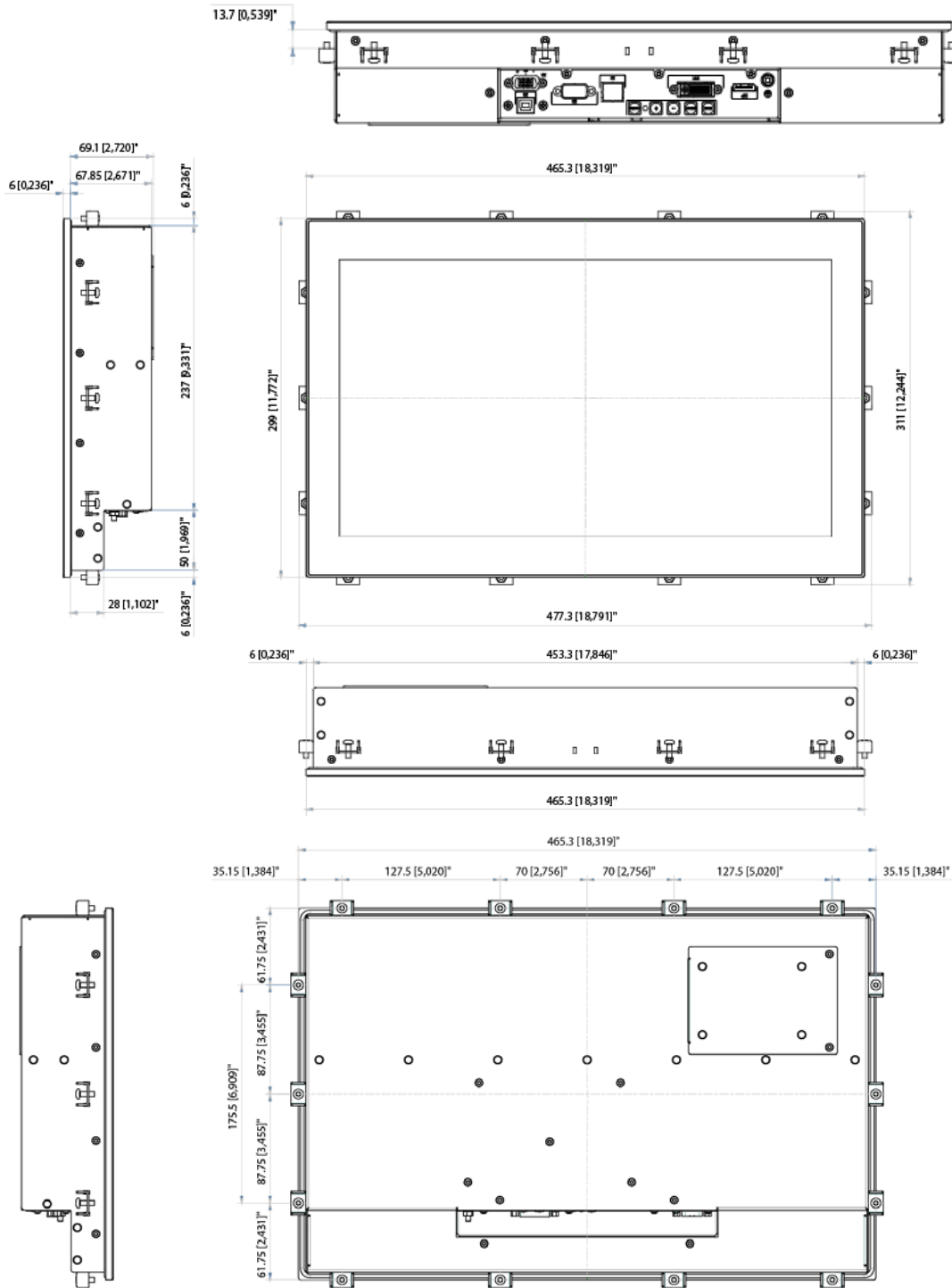

7.22.1. 18.5" Panel Cutout

The built-in monitor's panel cutout dimensions are:

- ▶ Horizontal: 455.3 mm [17.925"]
- ▶ Vertical: 289 mm [11.378"]

7.23. 18.5" Full-metal VESA Variant (HD and FullHD)

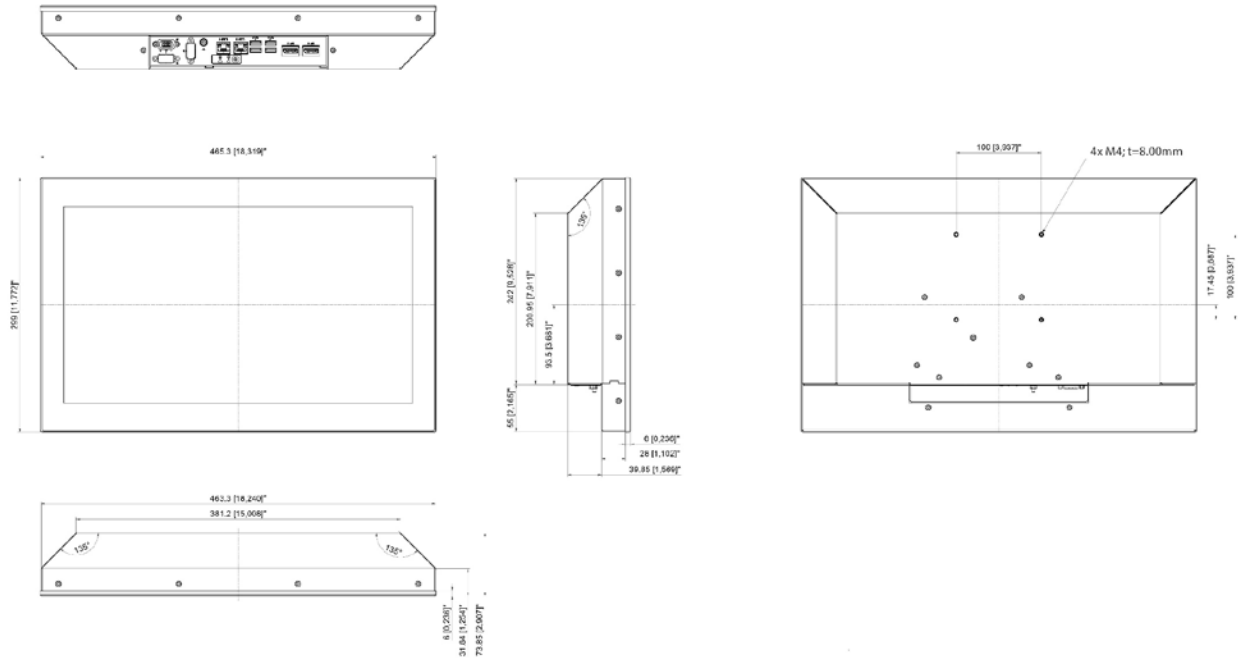

7.24. 18.5" VESA Slim Variant (HD and FullHD)

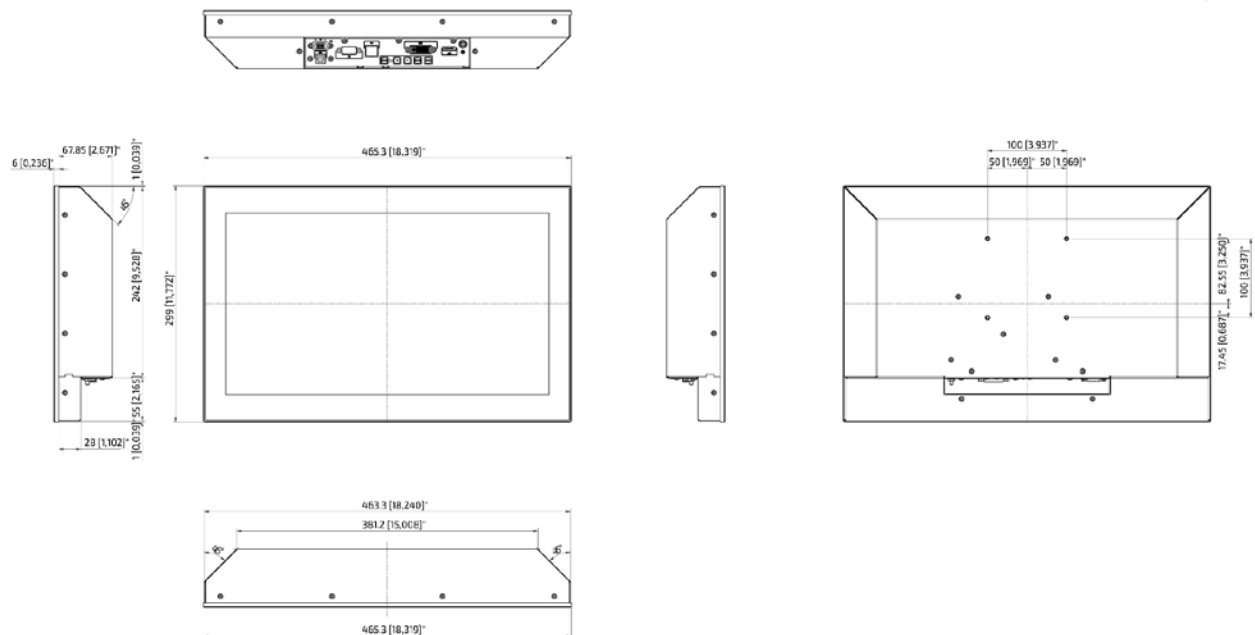

7.25. 19.0" Built-in Variant

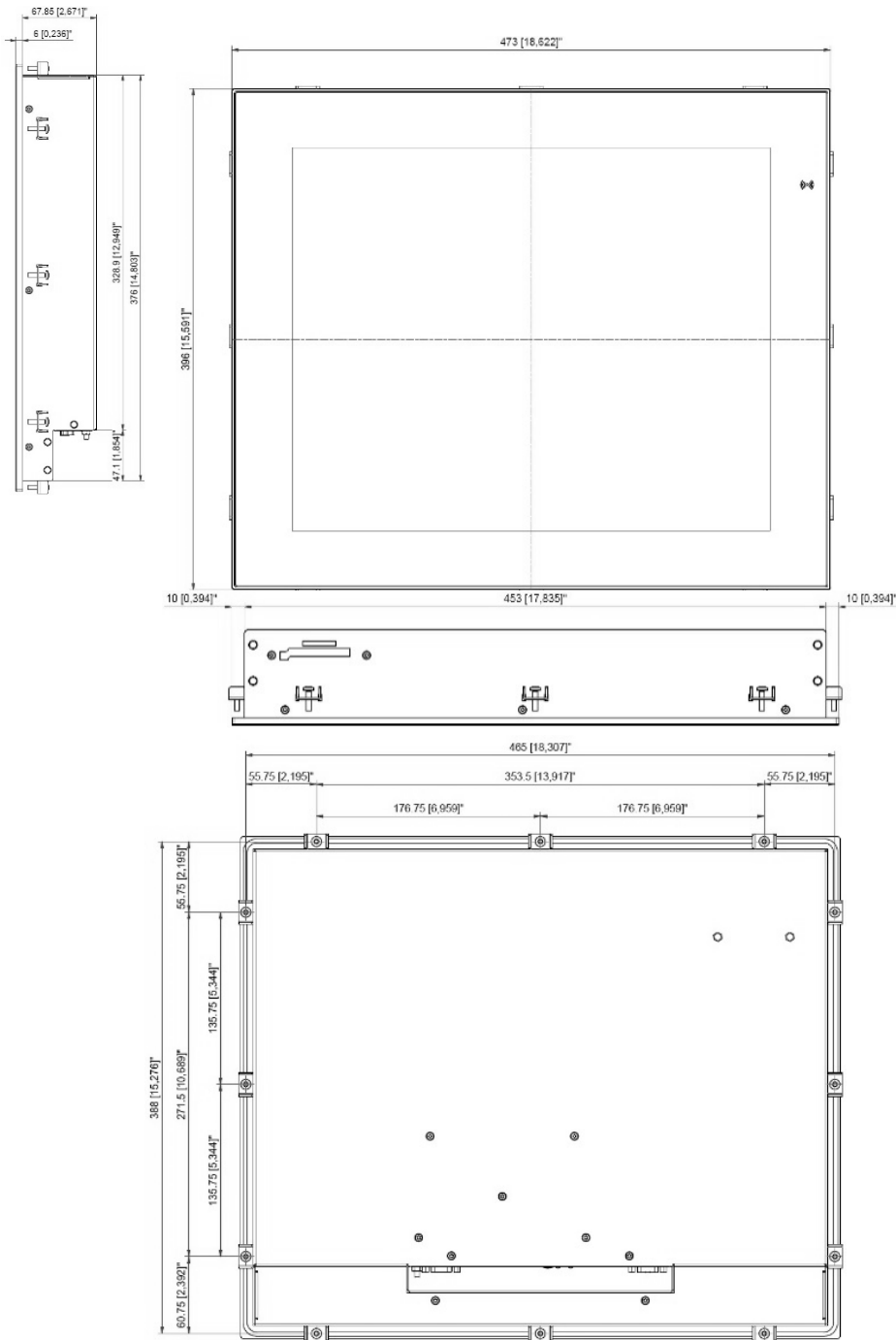

7.25.1. 19.0" Panel Cutout

The built-in monitor's panel cutout dimensions are:

- ▶ Horizontal: 455 mm [17.913"]
- ▶ Vertical: 378 mm [14.882"]

7.26. 19.0" Full-metal VESA Variant

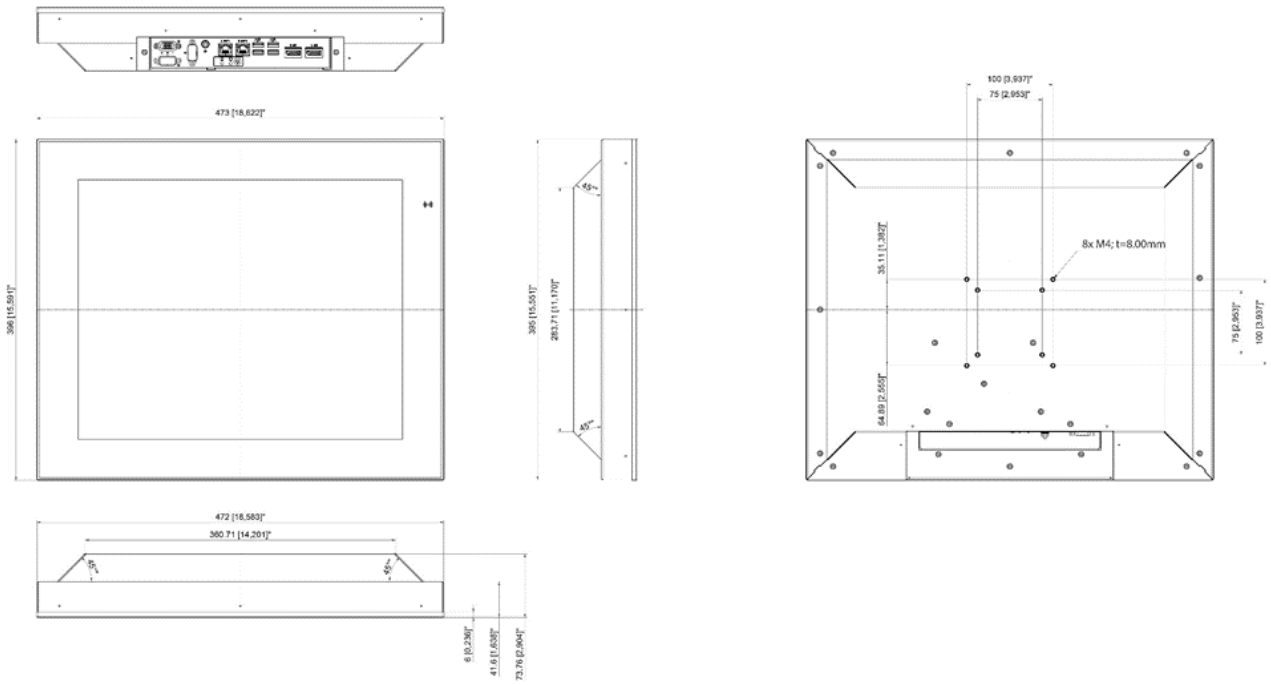

7.27. 19" Monitor Rackmount (RCK)

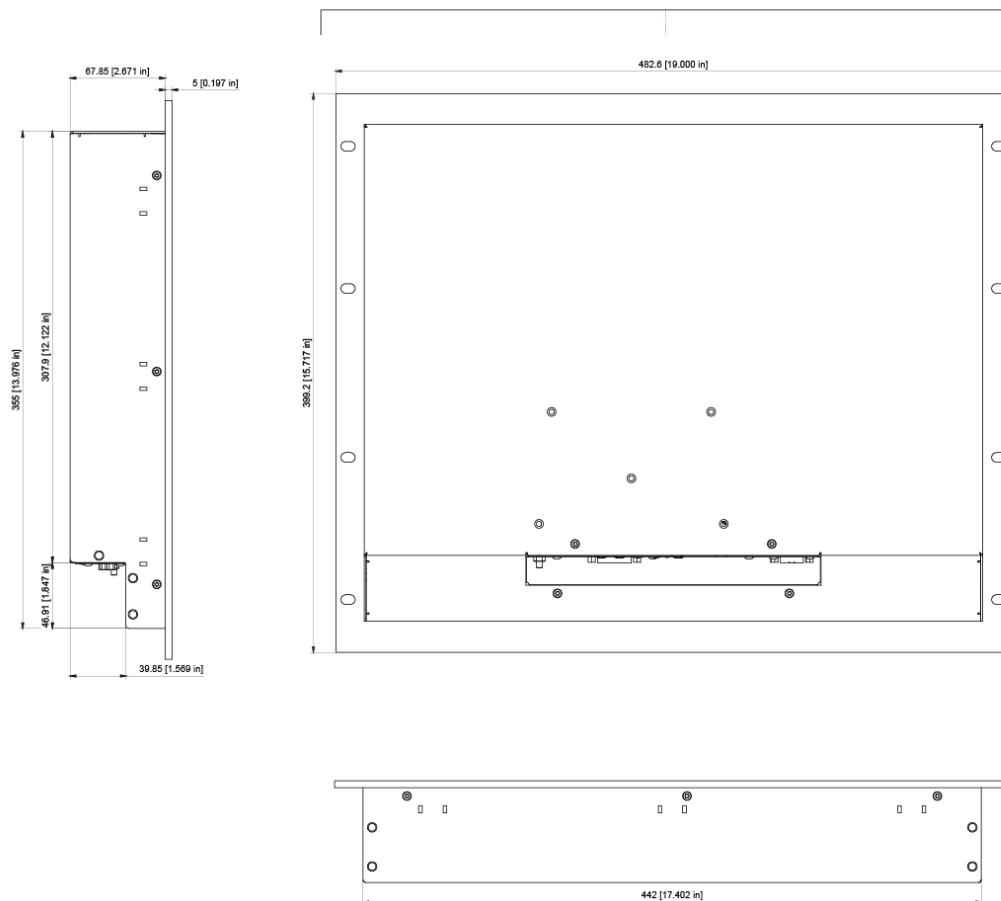

21.5" Built-in Variant

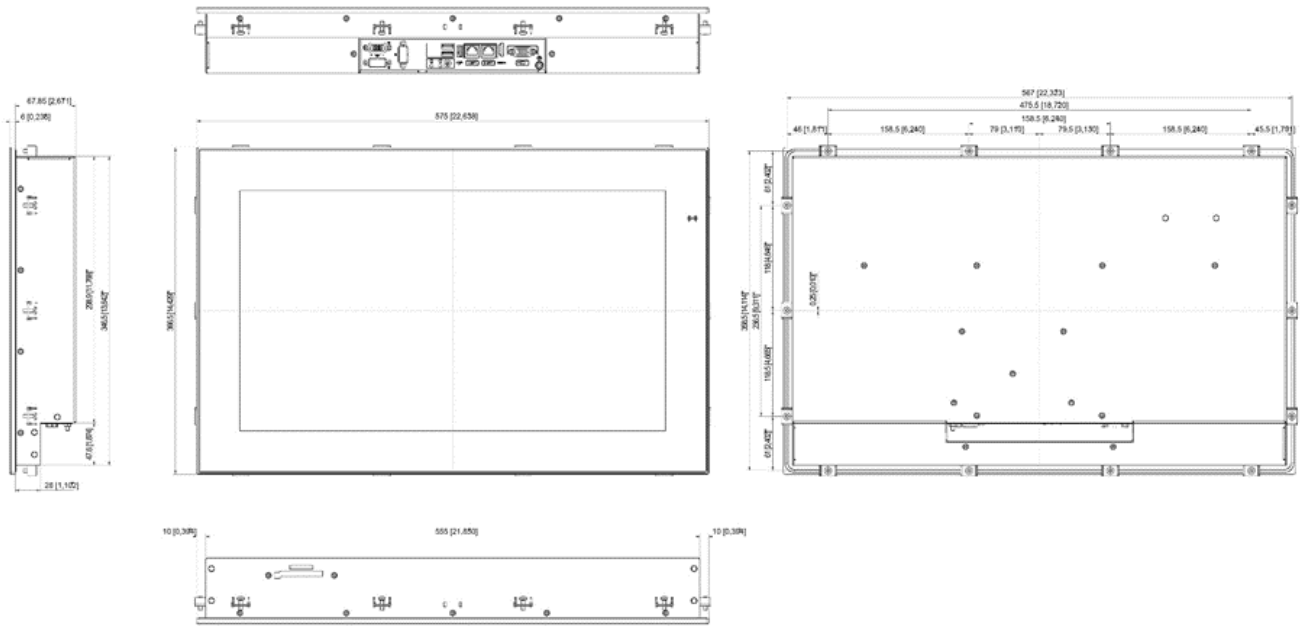

7.27.1. 21.5" Panel Cutout

The built-in monitor's panel cutout dimensions are:

- ▶ Horizontal: 557 mm [21.929"]
- ▶ Vertical: 348.5 mm [13.720"]

7.28. 21.5" Built-in Slim Variant (HD and FullHD)

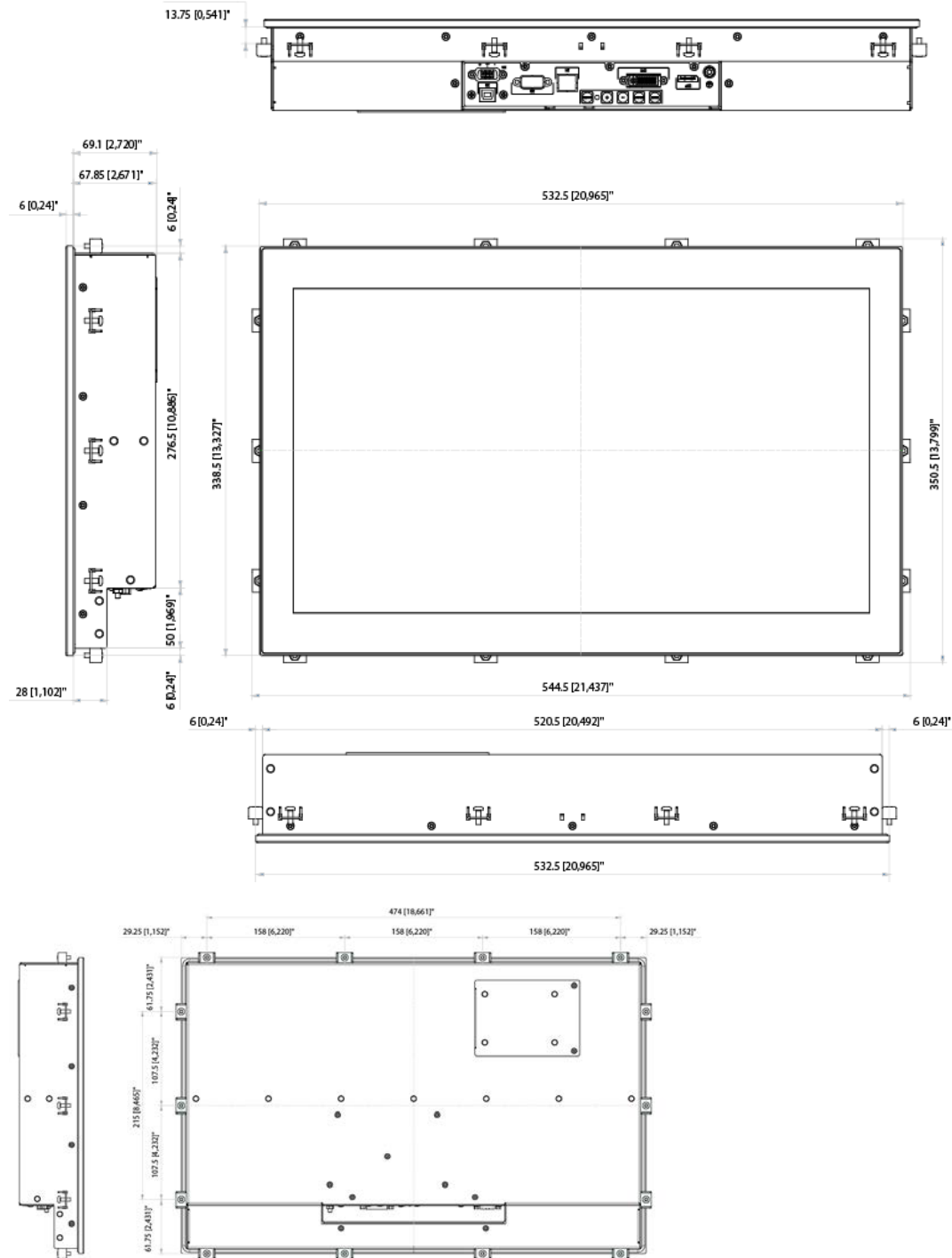

7.28.1. 21.5" Slim Variant Panel Cutout

The built-in monitor's panel cutout dimensions are:

- ▶ Horizontal: 522.5 mm [20.571"]
- ▶ Vertical: 328.5 mm [12.933"]

7.29. 21.5" Full-metal Variant

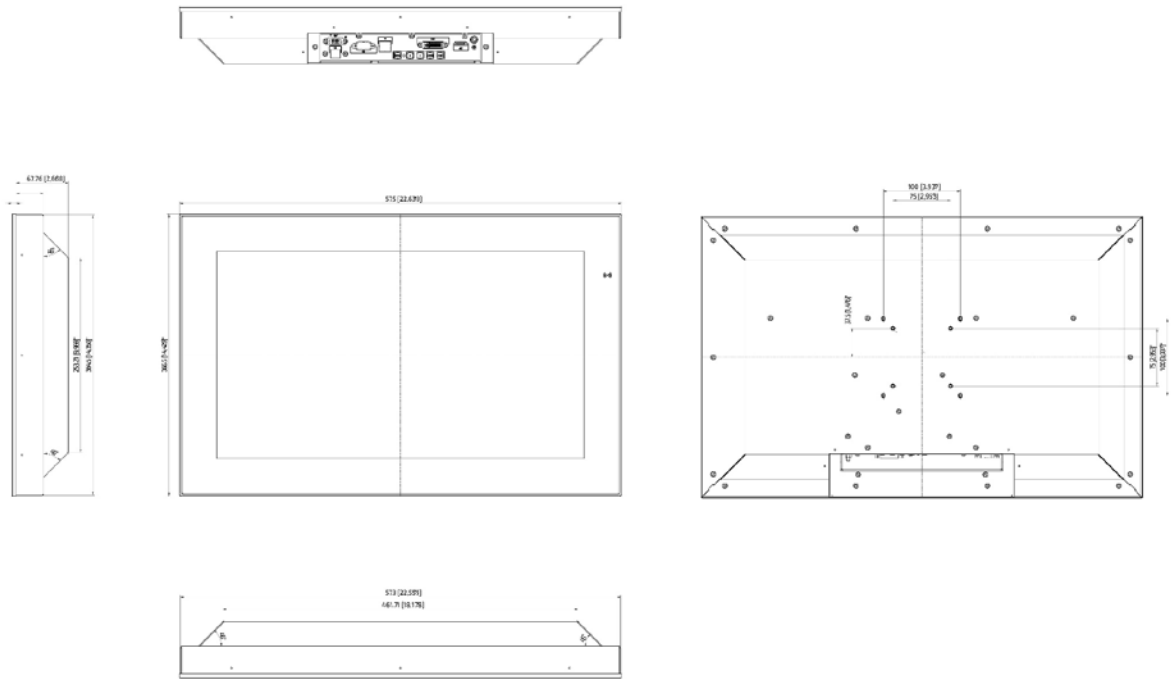

7.30. 21.5" VESA Slim Variant

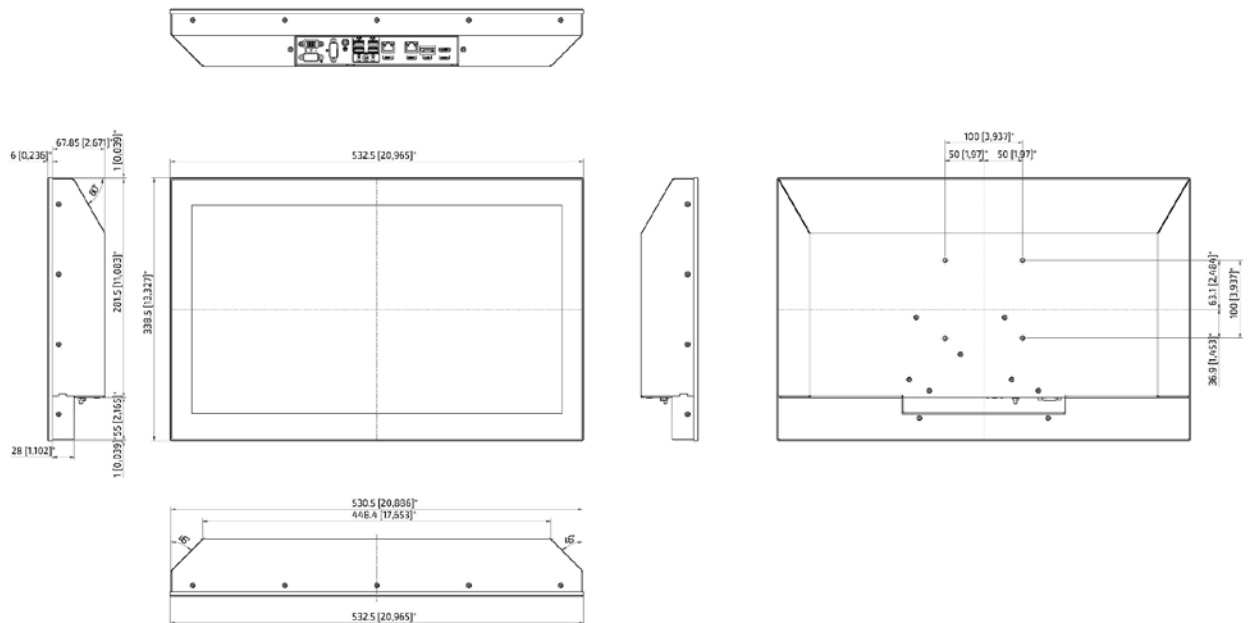

7.31. 23.8" Built-in Variant

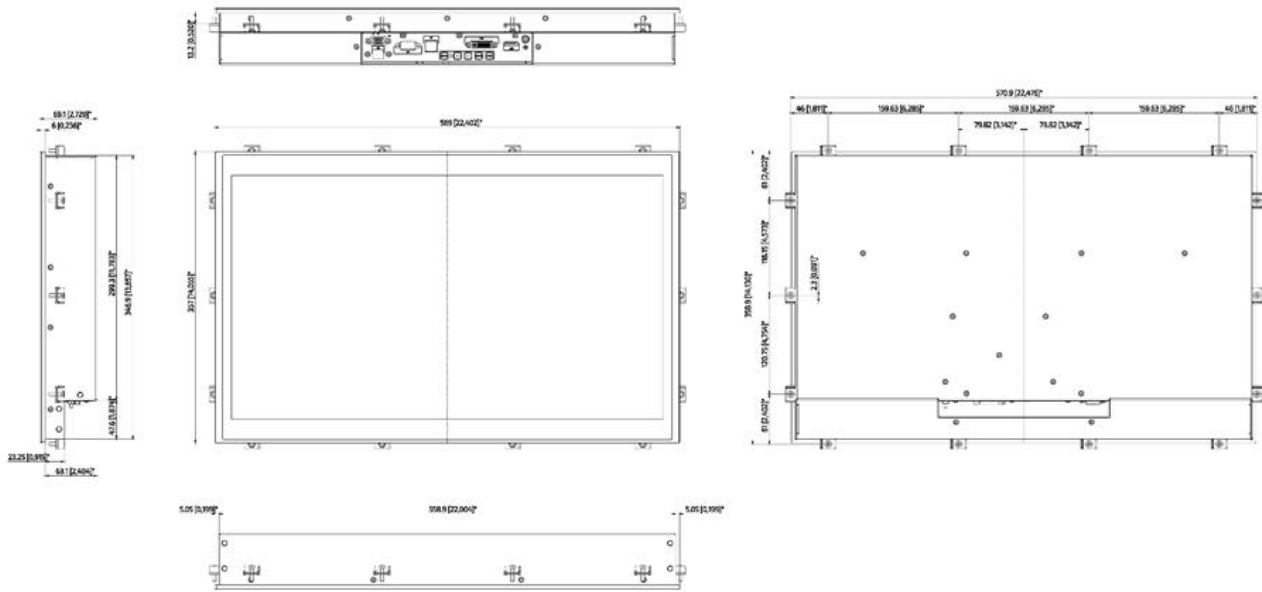

7.31.1. 23.8 "Panel Cutout

The built-in monitor's panel cutout dimensions are:

- ▶ Horizontal: 561 mm [22.087"]
- ▶ Vertical: 349 mm [13.740"]

7.32. 23.8" Full-metal Variant

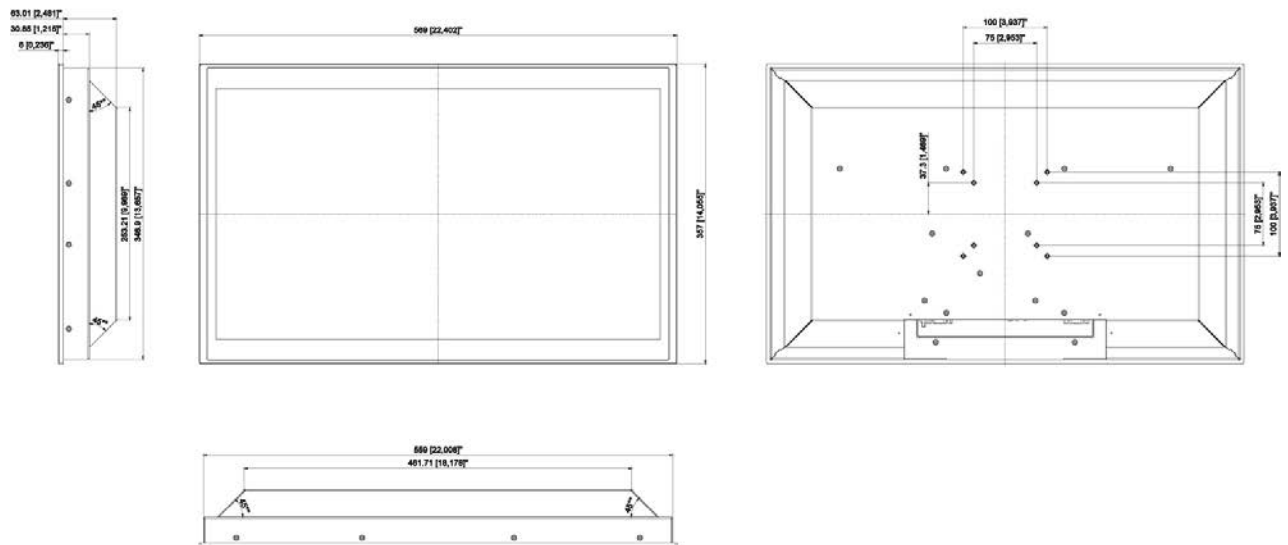

8/ Connectors

8.1. FlatClient ECO Intel BayTrail J1900

Figure 6: Interfaces for Panel PC FlatClient ECO

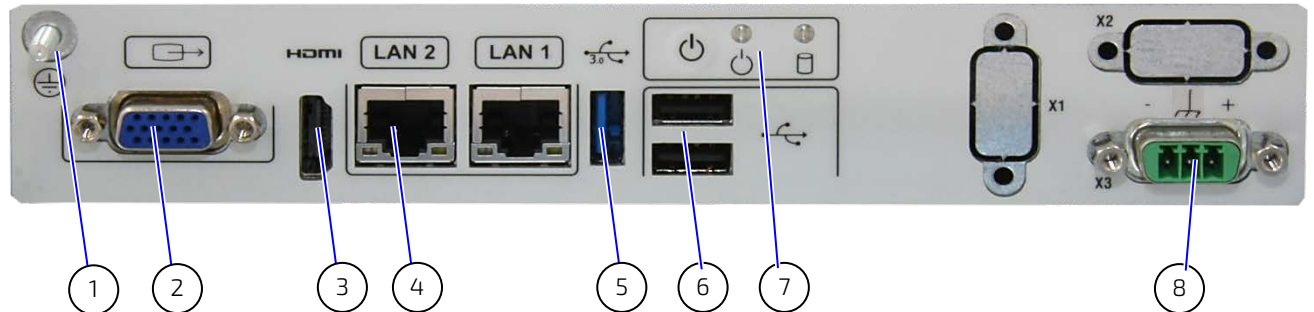

- | | | | |
|---|---------------|---|-----------------|
| 1 | Earth stud | 5 | USB 3.0 |
| 2 | VGA connector | 6 | 2x USB 2.0 |
| 3 | HDMI | 7 | Power/LEDs |
| 4 | 2x GbE | 8 | Power connector |

8.2. FlatClient ECO Intel BayTrail J1900 7" Variant

Figure 7: Interfaces for Panel PC FlatClient ECO 7" variant

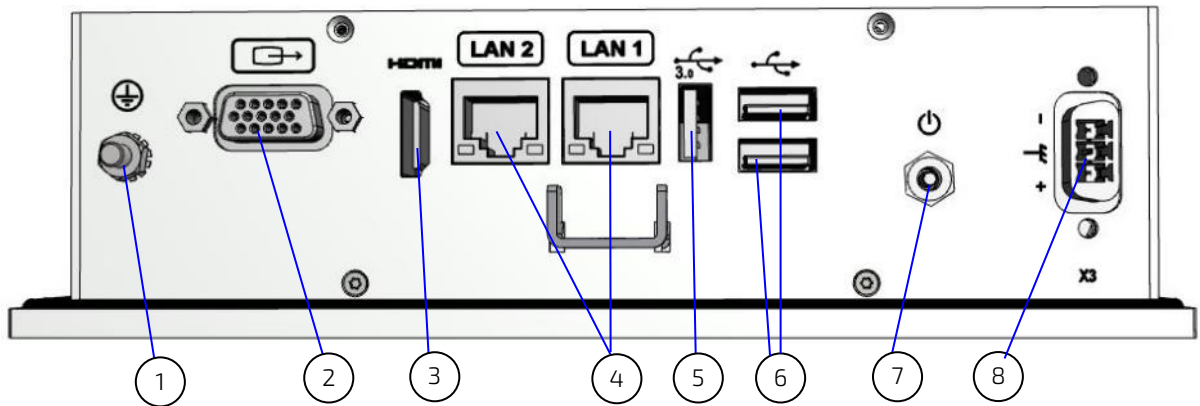

- | | | | |
|---|---------------|---|-----------------|
| 1 | Earth stud | 5 | USB 3.0 |
| 2 | VGA connector | 6 | 2x USB 2.0 |
| 3 | HDMI | 7 | Power/LEDs |
| 4 | 2x GbE | 8 | Power connector |

8.2.1. Input Power Connector

Figure 8: Input Power Connector

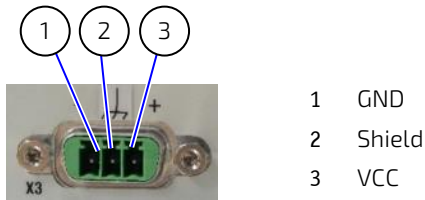

Figure 9: Mating Power Connector



Manufacturer: Phoenix Contact

Product: PSC 1,5/ 3-F

Order#: 1841909

8.2.2. Power-Switch and LEDs

Figure 10: Power-Switch and LEDs

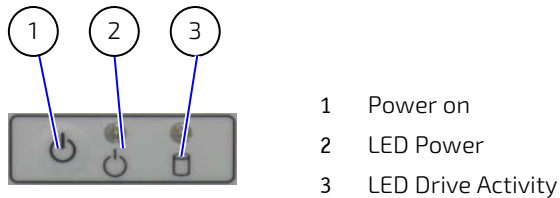

Table 18: Button Functions (1)

Button Functions	Activity
Pressed during active system	OS is put into sleep state
Pressed when power LED is green-blinking	OS is started from sleep state
Pressed when system was shut-down	New OS start

Table 19: Power LED (2)

LED	Signal
Off	No Power
Green	Active
Green blinking	Standby

Table 20: Drive Activity (3)

LED	Signal
Off	No Power
Blinking	Active

8.2.3. USB2.0 Type-A Connector

Table 21: Pinout USB 2.0

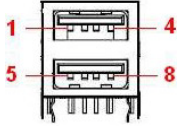
	Pin	Signal Name	Pin	Signal Name
	1	+USB_VCC	5	+USB_VCC
	2	USBA_A-	6	USBB_B-
	3	USBA_A+	7	USBB_B+
	4	GND	8	GND

8.2.4. USB3.0 Type-A Connector

Table 22: Pinout USB 2.0

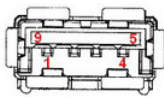
	Pin	Signal Name	Pin	Signal Name
	1	+USB_VCC	5	USB_RX-
	2	USB_D-	6	USB_RX+
	3	USB_D+	7	GND
	4	GND	8	USB_TX-
			9	USB_TX+

8.2.5. GbE RJ-45 Connector

Table 23: Pinout GbE RJ-45 Connector

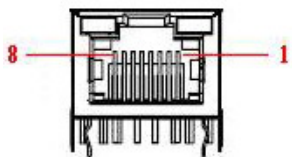
	Pin	Signal Name	Pin	Signal Name
	1	TX1+	5	TX3-
	2	TX1-	6	TX2-
	3	TX2+	7	TX4+
	4	TX3+	8	TX4-

8.2.6. LED Diagram of LAN Connectors

Table 8: Status of LEDs from GbE RJ-45 Connector

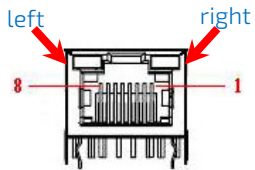
	left LED: activity/link		right LED: 10/100/1000	
	off	No LAN connectivity	off	10 Mbit
	yellow	link	green	100 Mbit
	yellow blinking	activity	orange	1 GbE

8.2.7. HDMI Connector

Table 24: Pinout HDMI Connector

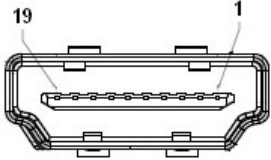
	Pin	Signal Name
		1
2		GND
3		TMDS Data2-
4		TMDS Data1+
5		GND
6		TMDS Data1-
7		TMDS Data0+
8		GND
9		TMDS Data0-
10		TMDS Clock+
11		GND
12		TMDS Clock-
13		Reserved
14		Reserved
15		DDC_CLK
16		DDC_DATA
17		GND
18		+5 V Power
19		Hot Plug Detect

8.2.8. DB15 VGA Connector

Table 25: Pinout VGA Connector

Pin	Signal Name	Pin	Signal Name
1	Red	2	Green
3	Blue	4	n.c.
5	GND	6	GND
7	GND	8	GND
9	VCC	10	GND
11	n.c.	12	DDC Data
13	Hsync	14	Vsync
15	DDC Clock		

8.2.9. COM2 RS-232/422/485 (via internal cable connection to CN16, Option)

Table 26: Pinout RS-232/422/485 Connector

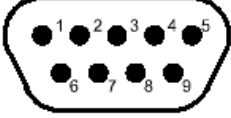
	Pin	RS-232	RS-422	Half Duplex RS-485	Full Duplex RS-485
	1	DCD	Tx-	DATA-	Tx-
	2	RxD	Tx+	DATA+	Tx-
	3	TxD	Rx+	-	Rx+
	4	DTR	Rx-	-	Rx-
	5	GND	GND	GND	GND
	6	DSR	-	-	-
	7	RTS	-	-	-
	8	CTS	-	-	-
	9	RI	-	-	-

8.3. FlatClient ECO Apollo Lake N4200/Intel® Celeron® J3455

Figure 11: Interfaces for Panel PC FlatClient Apollo Lake variant

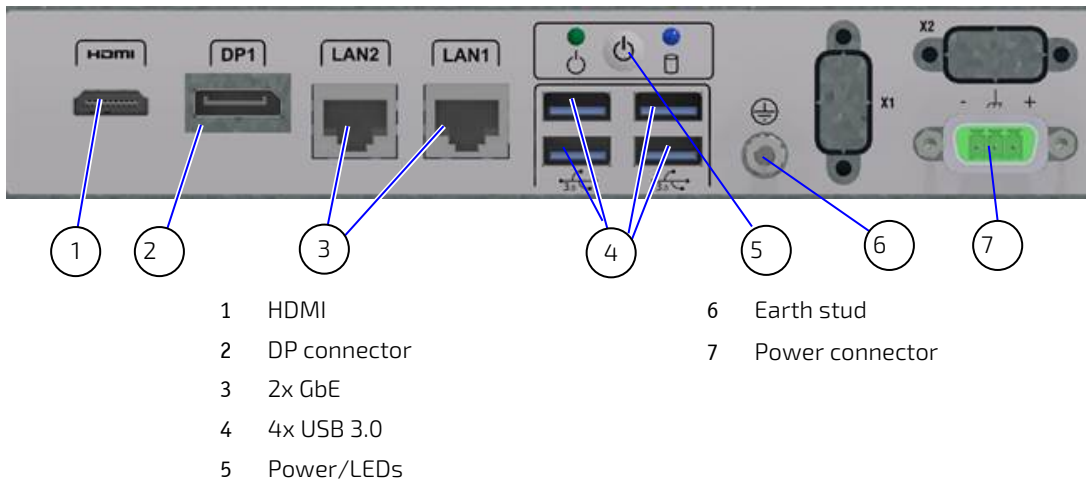

8.3.1. Input Power Connector

Figure 12: Input Power Connector

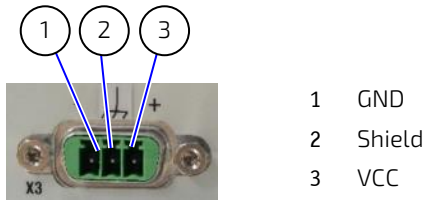

Figure 13: Mating Power Connector



Manufacturer: Phoenix Contact

Product: PSC 1,5/ 3-F

Order#: 1841909

8.3.2. Power-Switch and LEDs

Figure 14: Power-Switch and LEDs

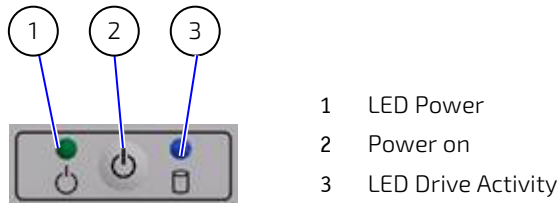

Table 27: Power LED (1)

LED	Signal
Off	No Power
Green	Active
Green blinking	Standby

Table 28: Button Functions (2)

Button Functions	Activity
Pressed during active system	OS is put into sleep state
Pressed when power LED is green-blinking	OS is started from sleep state
Pressed when system was shut-down	New OS start

Table 29: Drive Activity (3)

LED	Signal
Off	No Power
Blinking	Active

8.3.3. USB2.0 Type-A Connector

Table 30: Pinout USB 2.0

Pin	Signal Name	Pin	Signal Name
1	+USB_VCC	5	+USB_VCC
2	USBA_A-	6	USBB_B-
3	USBA_A+	7	USBB_B+
4	GND	8	GND

8.3.4. USB3.0 Type-A Connector

Table 31: Pinout USB 2.0

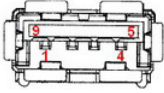
	Pin	Signal Name	Pin	Signal Name
	1	+USB_VCC	5	USB_RX-
	2	USB_D-	6	USB_RX+
	3	USB_D+	7	GND
	4	GND	8	USB_TX-
		9	USB_TX+	

8.3.5. GbE RJ-45 Connector

Table 32: Pinout GbE RJ-45 Connector

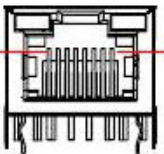
	Pin	Signal Name	Pin	Signal Name
	1	TX1+	5	TX3-
	2	TX1-	6	TX2-
	3	TX2+	7	TX4+
	4	TX3+	8	TX4-

8.3.6. LED Diagram of LAN Connectors

Table 33 : Status of LEDs from GbE RJ-45 Connector

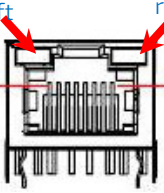
	left LED: activity/link		right LED: 10/100/1000	
	off	No LAN connectivity	off	10 Mbit
	yellow	link	green	100 Mbit
	yellow blinking	activity	orange	1 GbE

8.3.7. HDMI Connector

Table 34: Pinout HDMI Connector

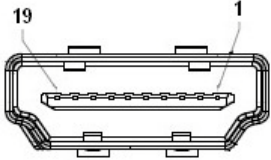
	Pin	Signal Name
		1
2		GND
3		TMDS Data2-
4		TMDS Data1+
5		GND
6		TMDS Data1-
7		TMDS Data0+
8		GND
9		TMDS Data0-
10		TMDS Clock+
11		GND
12		TMDS Clock-
13		Reserved
14		Reserved
15		DDC_CLK
16		DDC_DATA
17		GND
18		+5 V Power
19		Hot Plug Detect

8.3.8. DB15 VGA Connector

Table 35: Pinout VGA Connector

Pin	Signal Name	Pin	Signal Name
1	Red	2	Green
3	Blue	4	n.c.
5	GND	6	GND
7	GND	8	GND
9	VCC	10	GND
11	n.c.	12	DDC Data
13	Hsync	14	Vsync
15	DDC Clock		

8.3.9. COM2 RS-232/422/485 (via internal cable connection to CN16, Option)

Table 36: Pinout RS-232/422/485 Connector

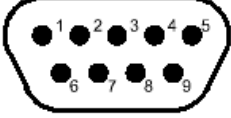
	Pin	RS-232	RS-422	Half Duplex RS-485	Full Duplex RS-485
	1	DCD	Tx-	DATA-	Tx-
	2	RxD	Tx+	DATA+	Tx-
	3	TxD	Rx+	-	Rx+
	4	DTR	Rx-	-	Rx-
	5	GND	GND	GND	GND
	6	DSR	-	-	-
	7	RTS	-	-	-
	8	CTS	-	-	-
	9	RI	-	-	-

8.4. FlatClient PRO Haswell

Figure 15: Interfaces for Panel PC PRO variant

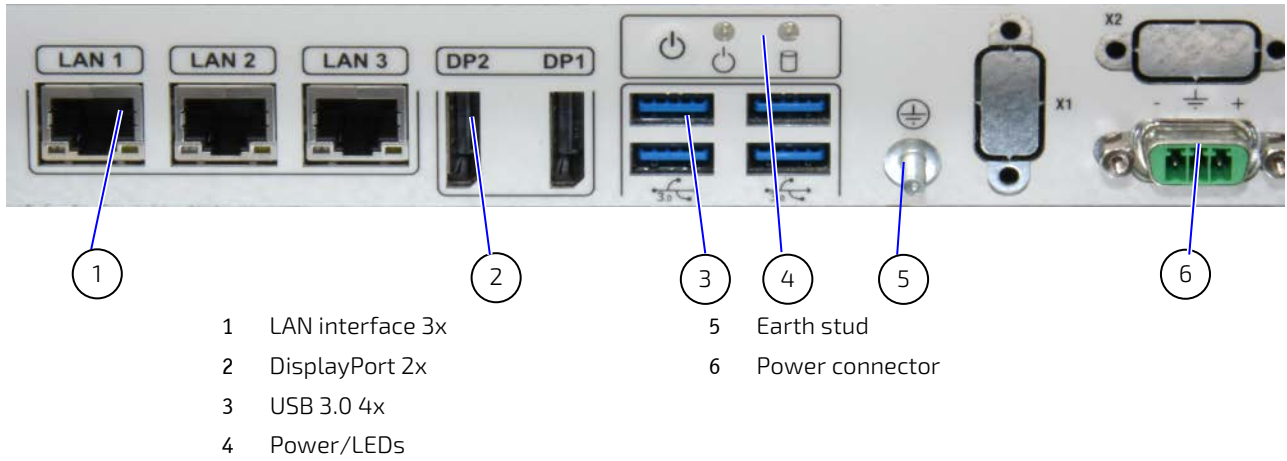

8.4.1. Input Power Connector

Figure 16: Input Power Connector

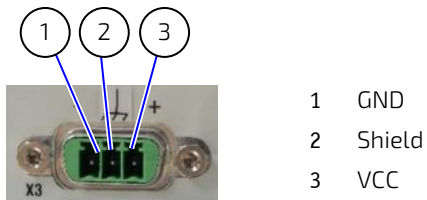

Figure 17: Mating Power Connector



Manufacturer: Phoenix Contact

Product: PSC 1,5/ 3-F

Order#: 1841909

8.4.2. Power-Switch and LEDs

Figure 18: Power-Switch and LEDs

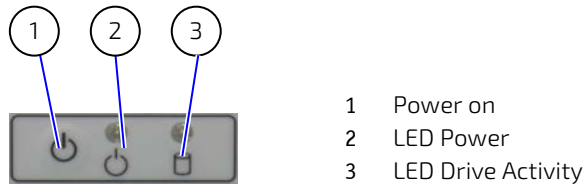

Table 37: Power On Button Functions (1)

Button Functions	Activity
Pressed during active system	OS is put into sleep state
Pressed when power LED is green-blinking	OS is started from sleep state
Pressed when system was shut-down	New OS start

Table 38: Power LED (2)

LED	Signal
Off	No Power
Green	Active
Green blinking	Standby

Table 39: Drive Activity (3)

LED	Signal
Off	No Power
Blinking	Active

8.4.3. USB3.0 Type-A Connector

The power source of +USBVCC can be selected by JP5.

Table 40: Pinout USB3.0 Connector

Pin	Signal Name	Pin	Signal Name
1	+USBA_VCC	10	+USBB_VCC
2	USBA_D-	11	USBB_D-
3	USBA_D-	12	USBB_D-
4	GND	13	GND
5	USBA_RX-	14	USBB_RX-
6	USBA_RX+	15	USBB_RX+
7	GND	16	GND
8	USBA_TX-	17	USBB_TX-
9	USBA_TX+	18	USBB_TX+

8.4.4. GbE RJ-45 Connector

Table 41: Pinout GbE RJ-45 Connector

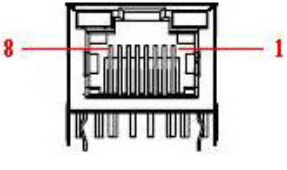
	Pin	Signal Name	Pin	Signal Name
	1	TX1+	5	TX3-
	2	TX1-	6	TX2-
	3	TX2+	7	TX4+
	4	TX3+	8	TX4-

8.4.5. LED Diagram of LAN Connectors

Table 8: Status of LEDs from GbE RJ-45 Connector

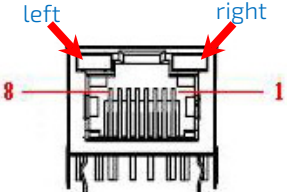
	left LED: activity/link		right LED: 10/100/1000	
	off	No LAN connectivity	off	10 Mbit
	yellow	link	green	100 Mbit
	yellow blinking	activity	orange	1 GbE

8.4.6. DisplayPort Connector

The Dual-Mode DisplayPort source automatically detects the presence of a plugged-in Dual-Mode DisplayPort cable adaptor and provides the DVI or HDMI signal, as required, to support the connected DVI or HDMI monitor.

Table 42: Pinout DisplayPort Connector

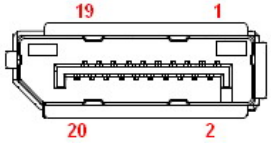
	Pin	Signal	Pin	Signal
	1	TX0+	11	GND
	2	GND	12	TX3-
	3	TX0-	13	GND
	4	TX1+	14	GND
	5	GND	15	AUX+
	6	TX1-	16	GND
	7	TX2+	17	AUX-
	8	GND	18	HPD
	9	TX2-	19	GND
	10	TX3+	20	PWR

8.4.7. COM2 RS-232/422/485 (via internal cable connection to CN16, Option)

Table 43: Pinout RS-232/422/485 Connector

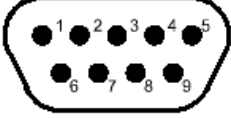
	Pin	RS-232	RS-422	Half Duplex RS-485	Full Duplex RS-485
	1	DCD	Tx-	DATA-	Tx-
	2	RxD	Tx+	DATA+	Tx-
	3	TxD	Rx+	-	Rx+
	4	DTR	Rx-	-	Rx-
	5	GND	GND	GND	GND
	6	DSR	-	-	-
	7	RTS	-	-	-
	8	CTS	-	-	-
	9	RI	-	-	-

8.5. FlatClient PRO Skylake/Kaby Lake/Whiskey Lake

Figure 19: Interfaces for Panel PC FlatClient PRO Skylake/Kaby Lake variant

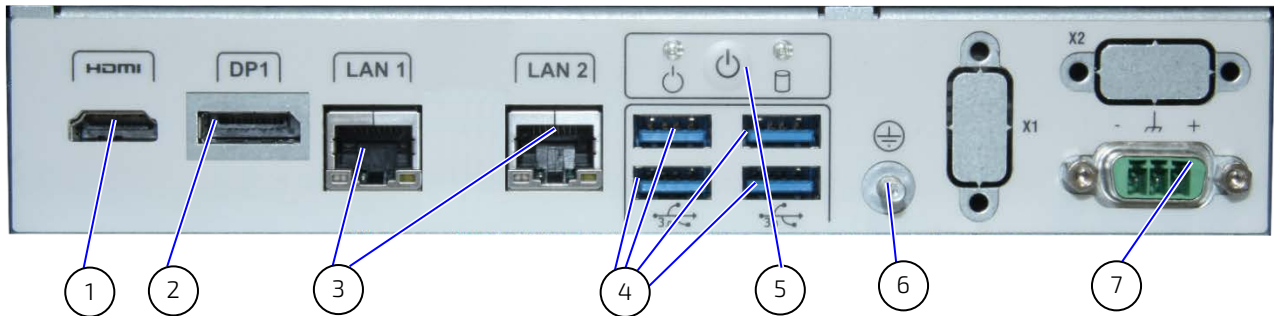

- | | | | |
|---|--------------|---|-----------------|
| 1 | HDMI | 6 | Earth stud |
| 2 | DP connector | 7 | Power connector |
| 3 | 2x GbE | | |
| 4 | 4x USB 3.0 | | |
| 5 | Power/LEDs | | |

8.5.1. Input Power Connector

Figure 20: Input Power Connector

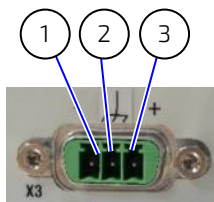

- | | |
|---|--------|
| 1 | GND |
| 2 | Shield |
| 3 | VCC |

Figure 21: Mating Power Connector



Manufacturer: Phoenix Contact

Product: PSC 1,5/ 3-F

Order#: 1841909

8.5.2. Power-Switch and LEDs

Figure 22: Power-Switch and LEDs

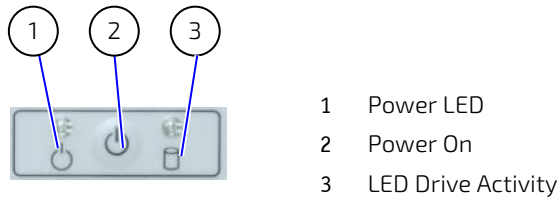

Table 44: Power LED (1)

LED	Signal
Off	No Power
Green	Active
Green blinking	Standby

Table 45: Button Functions (2)

Button Functions	Activity
Pressed during active system	OS is put into sleep state
Pressed when power LED is green-blinking	OS is started from sleep state
Pressed when system was shut-down	New OS start

Table 46: Drive Activity (3)

LED	Signal
Off	No Power
Blinking	Active

8.5.3. USB3.0 Type-A Connector

Table 47: Pinout USB 2.0

Pin	Signal Name	Pin	Signal Name
1	+USB_VCC	5	USB_RX-
2	USB_D-	6	USB_RX+
3	USB_D+	7	GND
4	GND	8	USB_TX-
		9	USB_TX+

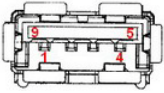

8.5.4. GbE RJ-45 Connector

Table 48: Pinout GbE RJ-45 Connector

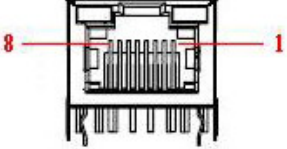
	Pin	Signal Name	Pin	Signal Name
	1	TX1+	5	TX3-
2	TX1-	6	TX2-	
3	TX2+	7	TX4+	
4	TX3+	8	TX4-	

8.5.5. LED Diagram of LAN Connectors

Table 8: Status of LEDs from GbE RJ-45 Connector

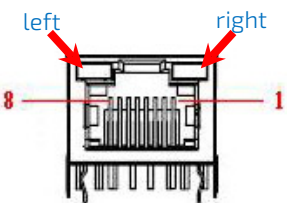
	left LED: activity/link		right LED: 10/100/1000	
	off	No LAN connectivity	off	10 Mbit
yellow	link	green	100 Mbit	
yellow blinking	activity	orange	1 GbE	

8.5.6. DisplayPort Connector

The Dual-Mode DisplayPort source automatically detects the presence of a plugged-in Dual-Mode DisplayPort cable adaptor and provides the DVI or HDMI signal, as required, to support the connected DVI or HDMI monitor.

Table 49: Pinout DisplayPort Connector

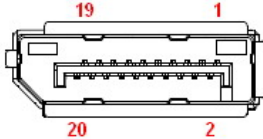
	Pin	Signal	Pin	Signal
	1	TX0+	11	GND
2	GND	12	TX3-	
3	TX0-	13	GND	
4	TX1+	14	GND	
5	GND	15	AUX+	
6	TX1-	16	GND	
7	TX2+	17	AUX-	
8	GND	18	HPD	
9	TX2-	19	GND	
10	TX3+	20	PWR	

8.5.7. HDMI Connector

Table 50: Pinout HDMI Connector

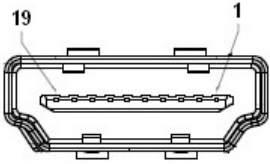
	Pin	Signal Name
	1	TMDS Data2+
	2	GND
	3	TMDS Data2-
	4	TMDS Data1+
	5	GND
	6	TMDS Data1-
	7	TMDS Data0+
	8	GND
	9	TMDS Data0-
	10	TMDS Clock+
	11	GND
	12	TMDS Clock-
	13	Reserved
	14	Reserved
	15	DDC_CLK
	16	DDC_DATA
	17	GND
	18	+5 V Power
	19	Hot Plug Detect

9/ Installation and Start

CAUTION

Do Not Mount Alone

Due to the weight of the FlatClient, mounting alone may result in product damage or personal injury.

NOTICE

FlatClient should be mounted in the vertical position $\pm 25^\circ$. Keep a clear distance all around the product of 50 mm. Make sure sufficient ventilation is provided and no other devices heat up the FlatClient.

NOTICE

FlatClient is intended for indoor use only. To avoid product damage do not use in a sheltered outdoor, outdoor or sunlit environment.

Observe that the product is not exposed to direct sunlight (UV radiation):

- Prolonged exposure shortens field life and voids the warranty
- Short exposure may lead to higher temperatures inside the product and cause permanent damage
- Direct exposure accelerates long-term aging

For intend use in an outdoor environment or a sunlit environment, contact your Kontron representative.

NOTICE





Handle with care to avoid damage to the front display screen.

9.1. Mounting Instructions Built-in-variant

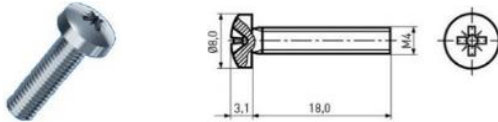
NOTICE

Fixation screw torque is 0,8 Nm \pm 0,2 Nm.

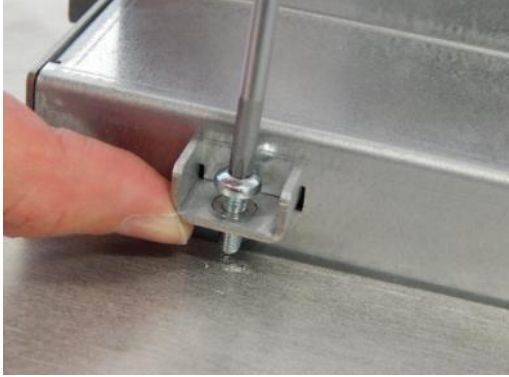
Step	Installation	Description
1	 	<ul style="list-style-type: none"> ▶ Use mounting set with screws and clamping brackets ▶ Lens head Screw Philips M4x12 ▶ DIN 7985 - ISO 7045 ▶ Use Philips head Screwdriver

Step	Installation	Description
2		<ul style="list-style-type: none"> ▶ Pre-assembly: Insert the screw into clamping bracket ▶ Note the right direction!
3		<ul style="list-style-type: none"> ▶ Insert the clamping bracket into your system
4		<ul style="list-style-type: none"> ▶ Fix the bracket with the screw to the housing
5		<ul style="list-style-type: none"> ▶ Repeat step 4 for all positions of clamping bracket

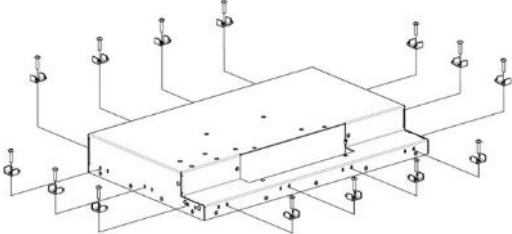
Step	Installation	Description
		

⚠ CAUTION**Verify Secure Mounting**

Always use all the clamping brackets and screws provided in the Mounting Set delivered with the FlatClient and mount on a mounting surface 3 mm to 7 mm thick.

9.2. Mounting Instructions VESA

To mount the FlatClient (VESA) use always all four VESA pattern (75/75 mm or 100/100 mm) M4 threaded holes. Do not use screws longer than 8 mm.

9.3. Mounting Instructions Rack

⚠ WARNING

The 19" rack must be stable. To improve stability:

- Install products from the bottom up
- Place heavy products lower down
- Bolt the rack to the floor or anchor the rack to the wall

⚠ CAUTION**Verify Secure Installation**

To ensure a secure installation that supports the product's weight use all screw holes provided on the right and left sides of the 19" rackmount frame.

To mount the FlatClient RCK in a 19" industrial rack, perform the following:

1. Fasten the FlatClient RCK using all the mounting hole provided on the left and right sides of the frame.
2. Take care not to over tighten the screws and check that the FlatClient RCK is securely mounted.

9.4. Startup Procedure

Before connecting the FlatClient to an external DC power supply, observe the General Safety Instructions within this user guide and the instructions within this chapter, and ensure that the power supply complies with the product's electrical specification, on the Type Label.

The FlatClient boots automatically when connected to power and restarts automatically when power returns after an interruption.

⚠ CAUTION

To not switch on or handle the product if there is any visible damage.

⚠ CAUTION

Only connect the product to an external power supply providing the voltage type (AC or DC) and the input power (max. current) specified on the Kontron Product Label.

The external power supply must meet the requirements of ES1/PS2 according to IEC/UL 62368-1.

Connectez le produit uniquement à une alimentation externe fournissant le type de tension (AC ou DC) et la puissance d'entrée (courant max.) spécifiés sur l'étiquette du produit Kontron. L'alimentation externe doit répondre aux exigences de ES1/PS2 selon IEC/UL 62368-1.

⚠ CAUTION

Switching off the product by its power button does not disconnect it from the mains. Complete disconnection is only possible if the power cable is removed from the wall plug or from the product. Ensure that there is free and easy access to enable disconnection.

NOTICE

To protect the product and any connected peripherals, make sure that the power cables have the right diameter to withstand the maximum available current.

NOTICE

Support the power and I/O cables to minimize the strain on the connectors.

NOTICE

The last cable to be connected must always be the power cable.



All essential drivers are available in Kontron Customer section, visit [Customer Section | Kontron Europe and Asia](#).

9.4.1. Connecting to a Power Supply

To connect the FlatClient to the Kontron AC/DC power supply with mating power connector, perform the following:

1. Connect the power supply to the power connector (Figure 4, pos. 7 and Figure 5, pos. 5), using the Phoenix connector. Pay attention to the polarity of the connections.
2. Connect the power cord to the mains power source.
3. When connected to power, the FlatClient boots automatically and the LED "PWR" illuminates.

To connect the FlatClient to an external 24 VDC power supply, perform the following

1. Wire the mating power connector with an appropriate wired power cabled as described in Chapter 9.4.2: Wiring the Mating Power Connector.
2. Switch off the external DC power supply via a disconnecting device (fuse/circuit breaker), to ensure that no power flows during the connection procedure.
3. Connect the wired mating power connector to the power connector on the FlatClient's rear panel; see Figure 4, pos. 7 and Figure 5, pos 5. Pay attention to the polarity of the connections.
4. Connect the other end of the wired mating power connector cable to the external 24 VDC power supply and switch on the external 24 VDC power supply.
5. When connected to power, the FlatClient boots automatically and the power indicator LED illuminates.

NOTICE

The wires used for power connections must be marked clearly (+/-/functional earth) to ensure a safe connection from the power connector to the DC power supply.

9.4.2. Wiring the Mating Power Connector

The wires must be clearly marked (+/-/functional earth) to ensure proper connection to the DC power supply.

Figure 23: Mating Power Connector

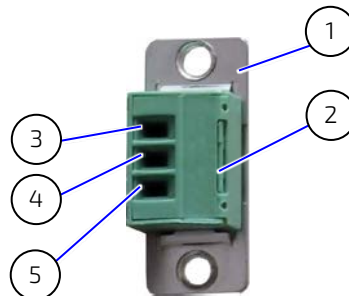

- | | | | |
|---|----------------------------------------|---|------------------------|
| 1 | 3-pin mating power connector | 3 | Clamp for 0 VDC wire |
| 2 | Cover over the slotted pan head screws | 4 | Clamp for earth wire |
| | | 5 | Clamp for +24 VDC wire |

To wire the supplied mating power connector, perform the following:

1. Cut three (1 mm²) AWG18 isolated wires to the required length and strip each end 5 mm – 7 mm.
2. Twist the striped wire-ends and provide them with ferrules.
3. Access the slotted pan head screws by opening the mating power connector's cover (Figure 23, pos. 2).
4. Loosen the slotted pan head screws far enough so that you can insert the end of the prepared wires.
5. Insert the wires into the corresponding clamp of the mating power connector. Pay attention to the polarity of the connections..
6. Fasten the screws to secure the wires into the mating power connector's clamps.
7. Close the mating power connector's cover (Figure 23, pos. 2).

NOTICE

Mark the wires clearly as (+/-/functional earth) to ensure a safe connection from the power connector to the DC power supply.

9.4.3. Switch On and Off

Once connected to power, switch off by performing an orderly system shutdown and using the power button on the rear panel's OSD keypad.

The power indicator LED illuminates or is off to indicate the current power state.

⚠ CAUTION

Switching off the product by its power button does not disconnect it from the mains. Complete disconnection is only possible if the power cable is removed from the wall plug or from the product. Ensure that there is free and easy access to enable disconnection.

NOTICE

Do not disconnect the power while the product is operating. This performs a forced shutdown and can lead to loss of data. To shutdown properly without data loss, switch off using the power button.

9.5. RFID (Optional)

Figure 24: Screen with optional RFID function (red circle)



The RFID reader is recognized and addressed as a Virtual COM port.

A tag can be read e.g. with a command in the terminal:

```
050010\r
```

10/ Technical Support

For technical support contact our Support Department:

- ▶ E-mail: support@kontron.com
- ▶ Phone: +49-821-4086-888

Make sure you have the following information available when you call:

- ▶ Product ID Number (PN),
- ▶ Serial Number (SN)



The serial number can be found on the Type Label, located on the product's rear side.

Be ready to explain the nature of your problem to the service technician.

10.1. Returning Defective Merchandise

All equipment returned to Kontron must have a Return of Material Authorization (RMA) number assigned exclusively by Kontron. Kontron cannot be held responsible for any loss or damage caused to the equipment received without an RMA number. The buyer accepts responsibility for all freight charges for the return of goods to Kontron's designated facility. Kontron will pay the return freight charges back to the buyer's location in the event that the equipment is repaired or replaced within the stipulated warranty period. Follow these steps before returning any product to Kontron.

1. Visit the RMA Information website:
<http://www.kontron.com/support-and-services/support/rma-information>

Download the RMA Request sheet for **Kontron Europe GmbH** and fill out the form. Take care to include a short detailed description of the observed problem or failure and to include the product identification Information (Name of product, Product number and Serial number). If a delivery includes more than one product, fill out the above information in the RMA Request form for each product.

2. Send the completed RMA-Request form to the fax or email address given below at Kontron Europe GmbH. Kontron will provide an RMA-Number.

Kontron Europe GmbH
RMA Support
Phone: +49 (0) 821 4086-0
Fax: +49 (0) 821 4086 111
Email: service@kontron.com

3. The goods for repair must be packed properly for shipping, considering shock and ESD protection.



Goods returned to Kontron Europe GmbH in non-proper packaging will be considered as customer caused faults and cannot be accepted as warranty repairs.

4. Include the RMA-Number with the shipping paperwork and send the product to the delivery address provided in the RMA form or received from Kontron RMA Support.

11/Storage, Transportation and Maintenance

11.1. Storage

If the product is not in use for an extended period time, disconnect the power plug from the power supply. If it is necessary to store the product then re-pack the product as originally delivered to avoid damage. The storage facility must meet the products environmental storage requirements as stated within this user guide. Kontron recommends keeping the original packaging material for future storage or warranty shipments.

11.2. Transportation

To ship the product use the original packaging, designed to withstand impact and adequately protect the product. When packing or unpacking products always take shock and ESD protection into consideration and use an EOS/ESD safe working area.

11.3. Maintenance

The FlatClient contains no user serviceable parts. To return the FlatClient for maintenance and repair, see Chapter **Error! Reference source not found.: Error! Reference source not found.**

CAUTION

There are no customer serviceable parts. If problems of a technical nature occur, contact [Kontron Support](#) or return for repair.

11.4. Cleaning the Display

When cleaning the display:

- ▶ Use a clean soft microfiber cloth.
- ▶ Use a commercially available glass cleaner or Ethanol Alcohol.
- ▶ Gently wipe the display with a cloth dampened with the glass cleaner.
- ▶ Do not press on the display when cleaning.

NOTICE

When cleaning the display, do not apply any pressure or use an abrasive substance/cloth that might scratch or damage the display's surface.

12/ Warranty

Due to their limited service life, parts that by their nature are subject to a particularly high degree of wear (wearing parts) are excluded from the warranty beyond that provided by law. This applies to the CMOS battery, for example.



If there is a protection label on your product, then the warranty is lost if the product is opened.

Appendix: List of Acronyms

AC	Alternating Current
CE	Conformité Européenne
COM	Communication port
DC	Direct Current
EMC	ElectroMagnetic compatibility
ESD	ElectroStatic Discharge
FCC	Federal Communications Commission
GbE	Giga Bit Ethernet
HD	High Definition
HDMI	High Definition Multimedia Interface
IOT	Internet of Things
LED	Light Emitting Diode
LPC	Limited Power Source
MTBF	Mean Time Before Failure
PS	Power Source
RFID	Radio Frequency Identification
RMA	Return of Material Authorization
RoHS	Restriction of Hazardous Substances
RTC	Real Time Clock
SD card	Secure Digital Card
SVGA	Super Video Graphics Array
TFT	Thin-Film Transistors
TPM	Trusted Platform Module
UEFI	Unified Extensible Firmware Interface
UL	Underwriters Laboratories
USB	Universal Serial Bus
UV	Ultra Violet
VESA	Video Electronics Standards Association
VGA	Video Graphics Array
WXGA	Wide Extended Graphics Array
XGA	Extended Graphics Array



About Kontron – Member of the S&T Group

Kontron is a global leader in Embedded Computing Technology (ECT). As a part of technology group S&T, Kontron offers a combined portfolio of secure hardware, middleware and services for Internet of Things (IoT) and Industry 4.0 applications. With its standard products and tailor-made solutions based on highly reliable state-of-the-art embedded technologies, Kontron provides secure and innovative applications for a variety of industries. As a result, customers benefit from accelerated time-to-market, reduced total cost of ownership, product longevity and the best fully integrated applications overall. For more information, please visit: <http://www.kontron.com/>



GLOBAL HEADQUARTERS

Kontron Europe GmbH

Gutenbergstraße 2
85737 Ismaning
Germany
Tel.: + 49 821 4086-0
Fax: + 49 821 4086-111
info@kontron.com